

322 HIGH BAY MULTISENSOR

Automatically control lighting loads at heights that are too high for general sensors

The High Bay Multisensor is a compact unit that provides energy-saving functions in DALI applications where mounting heights are too high for standard sensors, such as warehouses and factories.

Sealed with a gasket that protects it from dust and water, this IP65 sensor is designed to be recessed in a ceiling void or in a luminaire construction.

Since its detection sensitivity is less dependent on movement direction than that of most PIR sensors, fewer units are required to reliably cover a target area.

The unit features:

- A passive infrared detector (PIR), which detects movement within its coverage area, allowing load control in response to changes in space occupancy. It switches the lights on when its coverage area is occupied, and off when it is unoccupied
- A light sensor, which provides a bright-out function: it can be programmed in Designer to switch off the lights when the natural light rises above a predefined illuminance threshold.

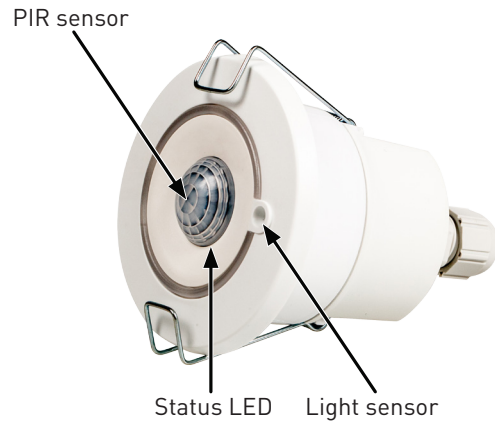

The High Bay Multisensor is compatible with Helvar's lighting systems and configuration software, Designer and Toolbox.

Key Features

- Excellent detection performance through high sensitivity and multidirectional coverage
- Suitable for applications with very high ceilings
- Protected against dust and water (IP65)
- Programmable bright-out control for energy efficiency*
- Simple connection and integration into a Helvar DALI control network.
- Programmable in Designer and Toolbox

* *Bright-out function is available only on a lighting router system.*

Presence Detection Coverage at 15 m Height

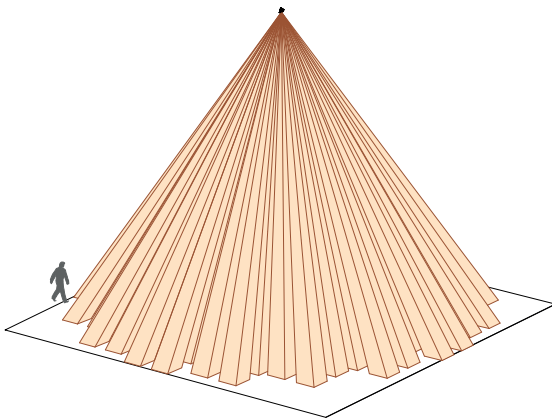

Presence Detection Coverage at 7.5 m Height

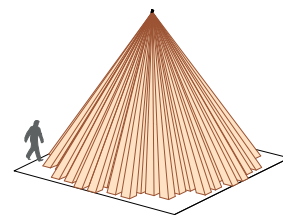

Detection pattern at floor level for 15 m mounting height

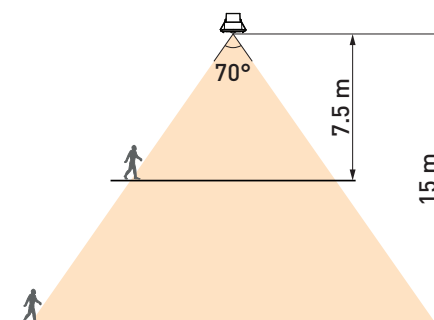
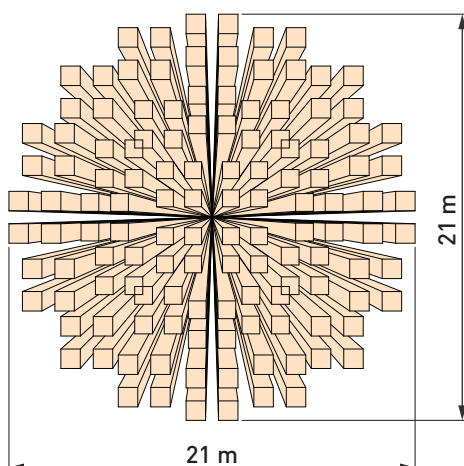

Detection pattern at floor level for 7.5 m mounting height

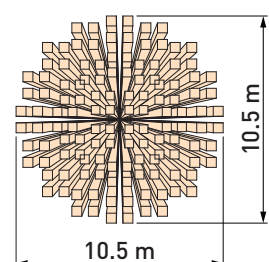

Technical Data

Connections

DALI:	Removable connector block
Cable jacket diameter:	4.5 mm – 7 mm
Wire section:	0.5 mm ² – 1.5 mm ² solid or stranded
Cable rating:	All cables must be mains rated.

Power

DALI supply input:	13 V – 22.5 V
DALI consumption:	5 mA

Sensors

Light sensor:	For bright-out function
Presence detector:	Passive infrared (PIR)

Mechanical data

Max. recommended mounting height:	17 m
Presence detection coverage area:	346 m ² @ 15 m mounting height 87 m ² @ 7 m mounting height
Mounting hole diameter:	52 mm – 55 mm
Bezel diameter:	66 mm
Recommended clearance depth:	12 cm (with cable cover, incl. 5 cm for cabling)
Material (casing):	Nonflammable PC/ABS (UL94-V0)
Finish / Colour:	Semi-matt / White RAL 9003
Weight:	70 g
IP code:	IP65

Operating and storage conditions

Ambient temperature:	0 °C to +50 °C
Relative humidity:	Max. 90 %, noncondensing
Storage temperature:	-10 °C to +70 °C

Conformity and standards

EMC emission:	EN 55015
EMC immunity:	EN 61547
Safety:	EN 61347-2-11
Environment:	Complies with WEEE and RoHS directives.

Software compatibility

Designer:	5.4.2 or later
Toolbox:	2.5.0 or later

Dimensions (mm)

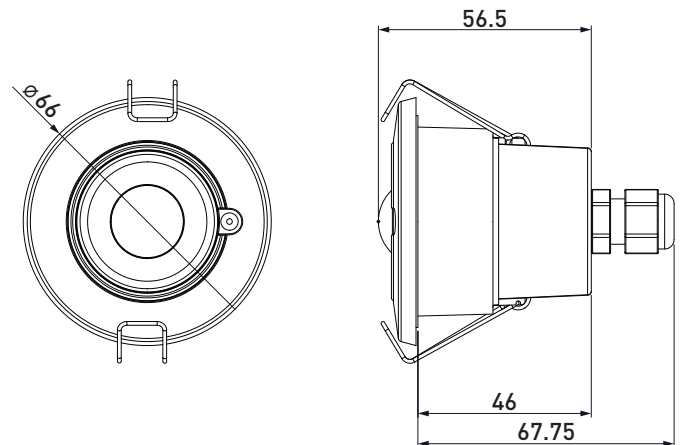

Connections

