

USER GUIDE
for the

HES92020, HES92021,
HES92220 & HES92221
DIMMER Modules

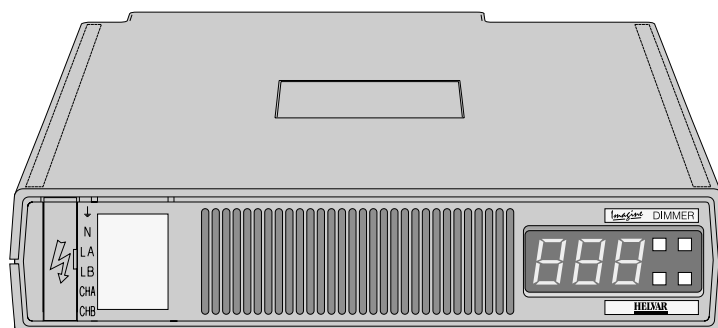

User Guide for the
Imagine HES92020, HES92021, HES92220 & HES92221 DIMMER Modules
Document I434B Issue 2 (21/08/02)

Copyright © 2002 Helvar Merca Ltd.
All rights reserved.

No part of this documentation may be reproduced or transmitted in any form or by any means, electronic or mechanical, including photocopying and recording, without the prior written permission of Helvar Merca Ltd.

The information in this documentation is supplied without warranty of any kind, either directly or indirectly, and is subject to change without prior written notice. Helvar Merca Ltd., its employees or appointed representatives will not be held responsible for any damages to software, hardware, or data, howsoever arising as a direct or indirect result of the product(s) mentioned herein.

Issued by:

Helvar Merca Ltd.,
Hawley Mill,
Hawley Road,
Dartford,
Kent,
DA2 7SY,
United Kingdom.

Printed in the United Kingdom.

PREFACE

Scope of this User Guide

The descriptions and instructions contained in this guide are based on the assumption that the *DIMMER* module is being installed and used as part of a Helvar Merca Ltd. *Imagine* Lighting System.

The installation instructions refer to the *DIMMER* module being installed in a *STACKER* unit.

Technical Specifications

Any technical data required for the correct installation and use of the *DIMMER* module is contained in this user guide.

For full technical specifications of this product, reference should be made to the Technical Source leaflets (ref: EPD02010 & EPD02015).

Firmware Version

The operational instructions contained in this user guide assume that the *DIMMER* modules are using the following firmware versions:

HES92020 & HES92021 version 2.3 firmware.

HES92220 & HES92221 version 4.5 firmware.

The dimmer module briefly reports the firmware version during power-up test. Refer to section 2, page 10 for further details.

Trade Marks

IMAGINE™, SCENESET™, SCENEMAKER™, SCENETIMER™, SCENE PLANNER™, SCENESOFT™, and SCENE COMMANDER™ are trade marks of Helvar.

This page is intentionally left blank.

CONTENTS

SECTION 1

INTRODUCTION **1**

GENERAL DESCRIPTION 2

EXTERNAL LAYOUT 3

 Front Panel 3

 Rear Panel 3

 Right Side Panel 3

 Left Side Panel 3

SECTION 2

INSTALLING THE *DIMMER* **5**

INPUT SUPPLY 6

 Voltage Range 6

 Frequency Range 6

 Supply Protection 6

INSTALLING INTO A STACKER UNIT 7

REMOVAL PROCEDURE 9

SETTING-UP PROCEDURE 10

 Stage 1 – Power-up Test 10

 Stage 2 – Set the Correct Dimming Law 10

 Stage 3 – Output Test 11

 Stage 4 – Set the Output Channel Addresses 11

SECTION 3

***DIMMER* OPERATING INSTRUCTIONS** **13**

CONTROLS AND DISPLAY FUNCTIONS 14

 Display Modes 14

 Control Lock-out 14

 Default Mode 14

 Changing the Display Mode 15

OUTPUT LEVEL MODE 16

 Output CHA & CHB Levels 16

 Operating Status 16

 S-DIM Data Line Status 16

 Changing the Output Levels 17

SCENESET Control 17

 Analogue Control 17

CHANNEL ADDRESS MODE	18
Parallel Operation	18
Control Lock-out	18
Changing the Channel Addresses	19
DIMMING LAW MODE	20
Output Characteristics	20
Changing the Dimming Law Table	21
HYSTERESIS MODE (Turn-on/ Turn-off Levels)	22
Changing the Turn-on and Turn-off Levels	23
SCENES<i>ET</i> NUMBER MODE	24
Checking the <i>SCENES<i>ET</i></i> Number	24
OUTPUT LEVEL OVERRIDE	25
Setting the Override Levels	25

SECTION 4

ANALOGUE CONTROL **27**

ANALOGUE CONTROL	28
Control Priority	28
Analogue Connector	28
Basic Analogue Control Circuit	29

SECTION 5

DIMMER TROUBLESHOOTING **31**

DIAGNOSTIC CODES	32
'Fatal' Codes	33
Self-recoverable Codes	34
Communication Codes	35
PROBLEM DIAGNOSIS	36

SECTION 1

INTRODUCTION

This section covers the following topics:

- General Description.
- External Layout.

GENERAL DESCRIPTION

The HES92020, HES92021, HES92220 and HES92221 *DIMMER* modules provide two channels of phase-controlled dimming which can be independantly controlled by the following methods:

- Local Control (Integral Control Panel).
- S-DIM (Serial DIMmer communications) Data Highway.
- Analogue Control Input.

The HES92020 and HES92021 uses SCR (silicon controlled rectifier) dimming technology and is recommended for use with 'inductive' loads such as conventionally wound transformers, flourescent ballasts and cold cathode ballasts.

The HES92220 and HES92221 uses power transistor dimming technology and is recommended for use with 'capacitive' loads (e.g. electronic transformers) and 'resistive' loads (e.g. tungsten lamps).

When used in an *Imagine* Lighting System, all of the *DIMMER* module's parameters are down-loaded from the *SCENESSET* module via the S-DIM data line.

IMPORTANT NOTE

The DIMMER module will not respond to S-DIM commands from an Imagine System until the output channel addresses have been correctly set.

EXTERNAL LAYOUT

Front Panel

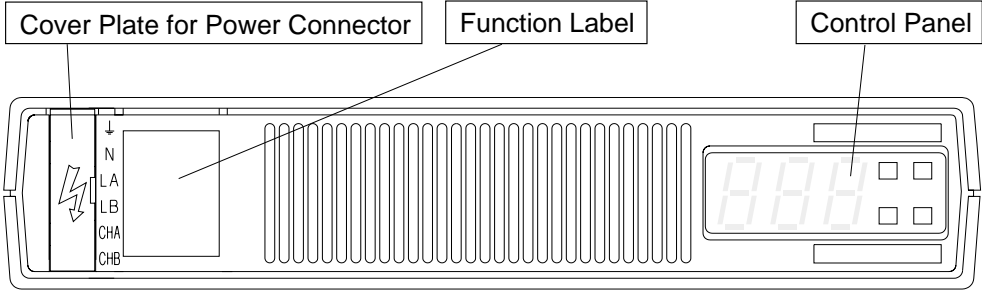

Rear Panel

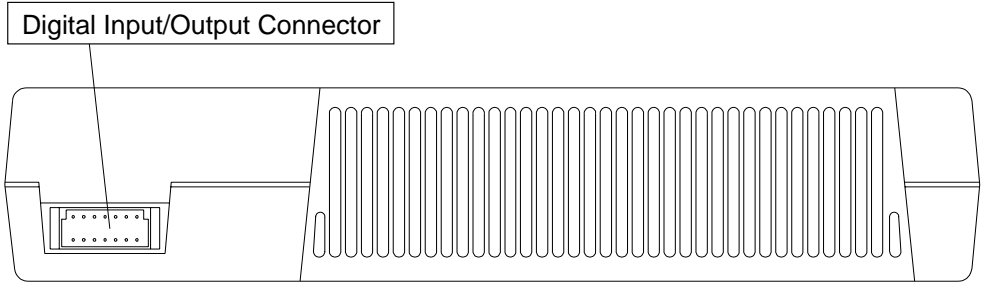

Right Side Panel

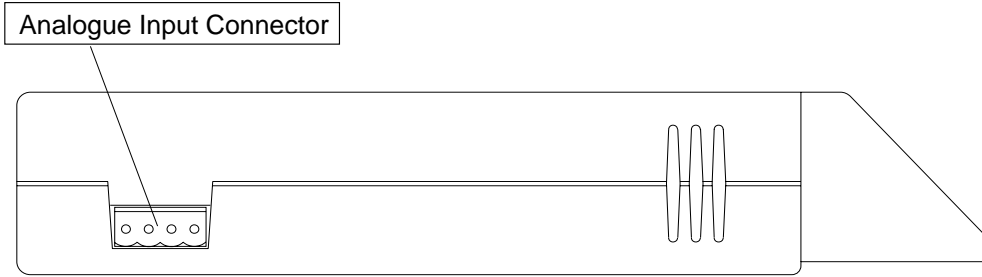

Left Side Panel

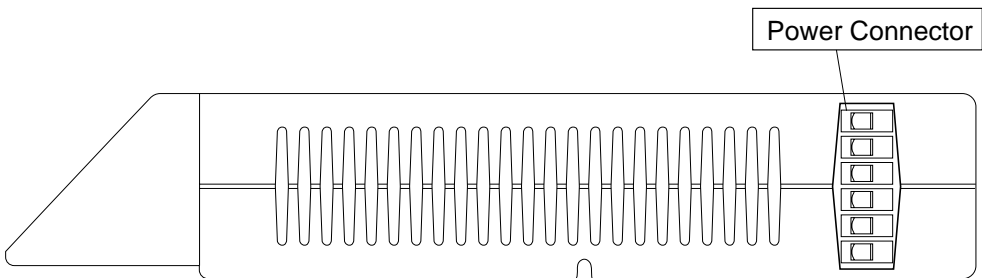

This page is intentionally left blank.

SECTION 2

INSTALLING THE *DIMMER*

This section covers the following topics:

- Input supply requirements.
- Installing into a *STACKER* unit.
- Connections for supply and outputs.
- Removal procedure.
- Setting-up procedure.

INPUT SUPPLY

Voltage Range

The *DIMMER* module is supplied factory-set for use with one of the following voltage ranges which cannot be changed by the user:

- HES92020 & HES92220, **230V a.c.** (nominal); **180V – 260V a.c.** (absolute),
or
- HES92021 & HES92221, **115V a.c.** (nominal); **90V – 130V a.c.** (absolute).

Check that the module is set for the correct range for the intended power supply by referring to the serial no./rating plate on the underside of the module.

CAUTION

Connecting a supply which exceeds the maximum limit for the appropriate input range may cause irreparable damage to the DIMMER module.

Frequency Range

The input supply frequency should be within the the range 45 – 65Hz. A supply frequency outside this range will cause the *DIMMER* module to shut-down.

Supply Protection

Where both channels are to be used separately, the supply input for each channel must be protected by a fuse or an MCB. Where an MCB is used, it is recommended that a double-pole type is used such that both channels are isolated or powered in tandem.

Where both channels are to be used in parallel to drive a high current load (Parallel Operation), the supply input to *must* be protected by a double-pole MCB.

The rating of the fuse or MCB will depend on the method of *DIMMER* cooling employed:

	Convection Cooled	Fan Cooled
MCB/Fuse rating (per Channel)	10A	20A

INSTALLING INTO A STACKER UNIT

WARNING

For your own safety, before attempting to install the DIMMER module, ensure that all of the input supply MCB's are in the 'off' position and if possible, isolate the MCB input terminals from the mains supply.

1. Carefully insert the *DIMMER* module into the appropriate slot of the *STACKER* unit, ensuring that the rear connector locates firmly into the motherboard at the back of the *STACKER*.
2. If required, secure the module to the *STACKER* by inserting a suitable retaining screw on the left-hand side (see Fig.2-1).

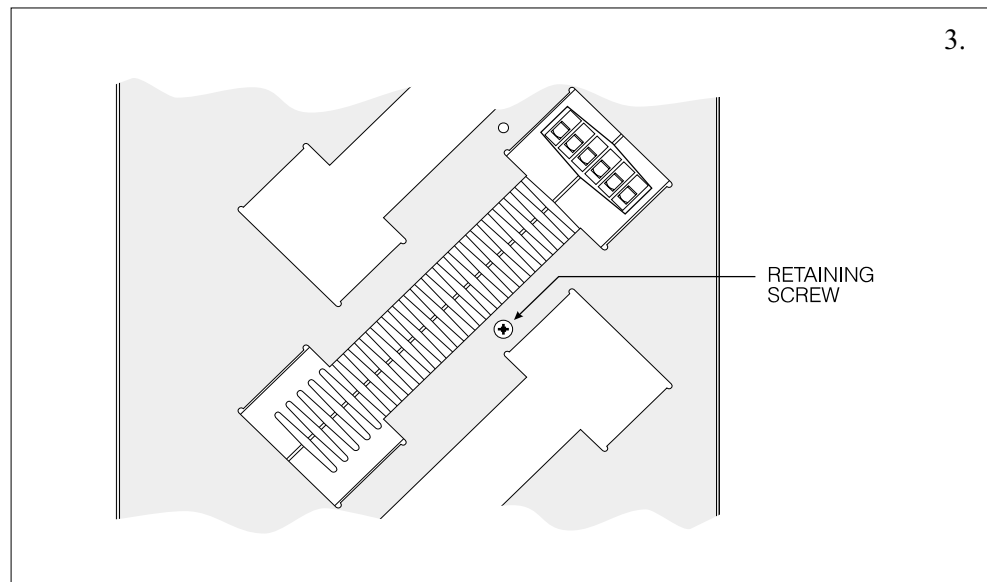

Fig.2-1: Location of retaining screw.

Insert the blade of a small flat-bladed screwdriver into the notch on the terminal cover plate, and gently prise out the plate to gain access to the terminal screws for the power connector (see Fig.2-2).

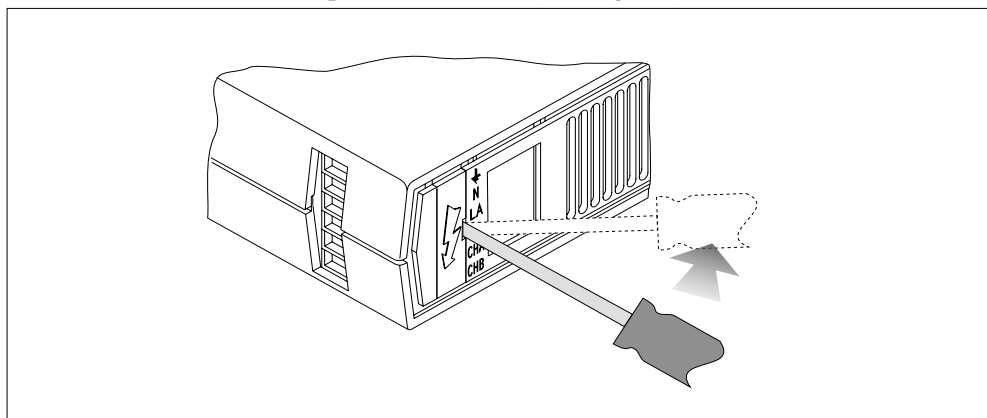

Fig.2-2: Removing the power terminal cover.

- Using suitable cable, make the following connections between the *DIMMER* module and the distribution panel:

WARNING
Both live feeds to terminals LA and LB must be of the same phase.

<i>DIMMER</i> Module	Distribution Panel	Wire Colour
Terminal \perp	Earth .	Green/Yellow.
Terminal N.	Neutral.	Blue.
Terminal LA.	Live feed from MCB.	Brown.
Terminal LB.	Live feed from MCB.	Brown.
Terminal CHA.	Appropriate output terminal.	Red.
Terminal CHB.	Appropriate output terminal.	Yellow.

Recommended cable type: TRI rated 105C (BS6231 approved).
 Cable size: 2.5mm².
 Stripping length: 12mm.
 Terminal screw torque: 0.8Nm.

- Clip the terminal cover back into position.
- Write the function or circuit details of both channels on the label in the recessed area of the front panel next to the terminal cover plate. If required, the label may be removed as shown in Fig.2-3.
- Make the connections, if required, to the analogue input, refer to page 28.

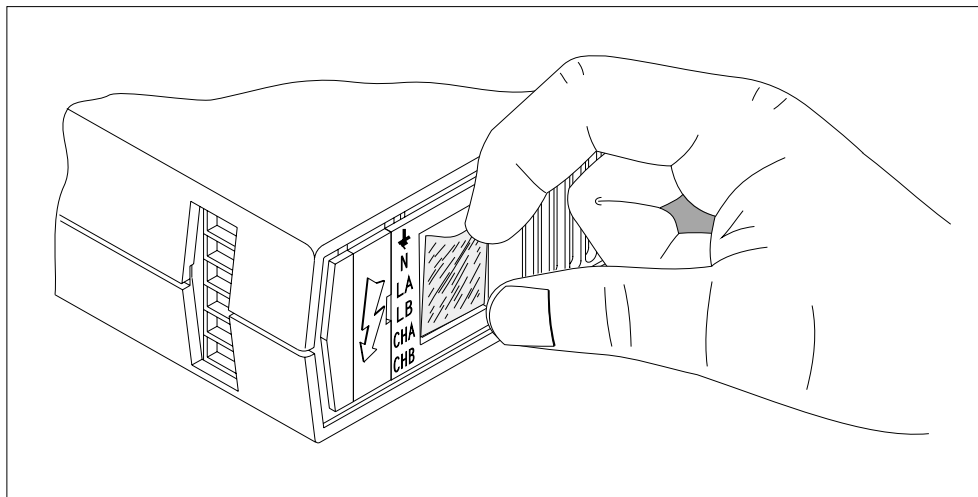

Fig.2-3: Removing the front panel label.

The physical installation of the *DIMMER* module is now complete. For the testing and setting-up procedure, refer to page 10.

REMOVAL PROCEDURE

If a *DIMMER* module needs to be removed from the *STACKER* unit, ensure that the channel addresses for both outputs are known.

If not, check the addresses by following the instruction procedure in section 3, page 18. Then proceed as follows:

WARNING

For your own safety, before attempting to remove the DIMMER module, ensure that all of the input supply MCB's are in the 'off' position and if possible, isolate the MCB input terminals from the mains supply.

1. Insert the blade of a small flat-bladed screwdriver into the notch on the terminal cover plate, and gently prise out the plate to gain access to the terminal screws for the power connector (see Fig.2-2).
2. Unscrew the terminals and withdraw each cable. It is suggested that the input and output cables are identified with a label to assist reconnection.
3. If the *DIMMER* module (or a replacement) is not to be refitted immediately, ensure that the ends of the connecting cables are made safe and secured away from all other connections.
4. Unplug any leads to the analogue input connector on the right-hand side.
5. Remove the locking screw (if fitted) from the left-hand side of the module (see Fig.2-1).
6. Grip the sides of the *DIMMER* firmly with both hands (through the slots in either side of the *STACKER*) and carefully ease the module forward to disengage the rear connector. Continue to ease the module out until the front is clear of the other modules enabling it to be withdrawn.

SETTING-UP PROCEDURE

The setting-up procedure for the *DIMMER* module is divided into four stages, which must be followed in the order listed below:

- Stage 1 – Power-up Test.
- Stage 2 – Set the Correct Dimming Law.
- Stage 3 – Output Test.
- Stage 4 – Set the Output Channel Addresses.

If it is not required to test the outputs (*i.e.* to check for correct load operation and wiring) then stages 2 & 3 may be omitted.

IMPORTANT NOTE

The DIMMER module will not respond to S-DIM commands from an Imagine System until the output channel addresses have been correctly set (stage 4).

Stage 1 – Power-up Test

Turn on the supply to the *DIMMER* module; the display will briefly show '888' and then clear to show the module's firmware version. This is displayed in the format 'V2.3' to represent V2.3. After 2 seconds the display reverts to the default mode (Fig.2.4).

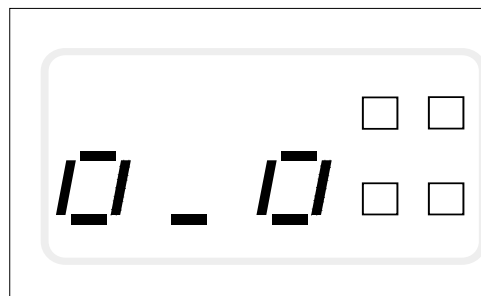

Fig.2-4: Default display.

When the display shows '888', the right-hand digit will be noticeably brighter than the others; this is normal and does not indicate a fault.

If the display clears to show a diagnostic code (a letter 'E' or 'F' followed by a two-digit number), the module has detected a problem. Refer to section 5, page 32 for further details.

Stage 2 – Set the Correct Dimming Law

The Dimming Laws applied to both *DIMMER* outputs are normally down-loaded via the S-DIM data line from the controlling *SCENESET* module.

However, if the outputs are to be tested, a Dimming Law appropriate to the output load type *must* be selected manually first. To set the Dimming Law, refer to section 3, page 20.

Stage 3 – Output Test

CAUTION

Before attempting this test, ensure that any loads connected to the DIMMER module outputs are suited to the Dimming Law selected. An incompatible Dimming Law or load type may result in damage to the module or the load.

Press and hold the top left-hand button on the DIMMER module's control panel. The left hand digit should step-up in value, and any light sources connected to output CHA should be seen to come on and increase in brightness accordingly.

Repeat this process for output CHB by pressing the top right-hand button.

Press and hold the lower buttons to return the outputs to zero level.

NOTE *If Dimming Law Table 0 is selected, the level will toggle between zero '0' and full power 'F'. Table 8 causes output CHB to behave as per Table 0 and to act under CHA control.*

Stage 4 – Set the Output Channel Addresses

Before the DIMMER module can operate correctly as part of the *Imagine* System, the Channel Address for each power output must be defined.

For details, refer to Section 3, page 18.

This page is intentionally left blank.

SECTION 3

DIMMER OPERATING INSTRUCTIONS

This section covers the following topics:

- Controls and Display Functions.
- Output Level.
- Channel Address.
- Dimming Law.
- Hysteresis (Turn-on and Turn-off Levels).
- *SCENESET* Number.
- Output Level Override.

CONTROLS AND DISPLAY FUNCTIONS

The *DIMMER* module has a control panel with four push-buttons and a three character digital display (Fig.3-1).

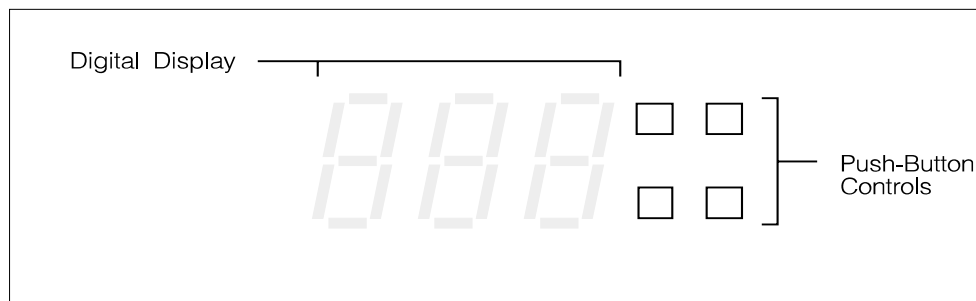

Fig.3-1: *DIMMER* control panel.

Display Modes

The display can be used in five different modes.

- Output Level.
- Channel Address.
- Dimming Law.
- Hysteresis (turn-on & turn-off level).
- *SCENESET* Number.

Each mode allows a particular setting for both dimmer outputs to be viewed and if required, a new value (except for the *SCENESET* number) can be entered.

When controlled by a *SCENESET* module it is necessary to set the channel addresses only. All other parameters will be set automatically.

Control Lock-out









The ability to change individual settings by using the integral control panel can be disabled or 'locked-out' by the controlling *SCENESET* module.

When a setting is locked-out, the value displayed will flash.

Default Mode

The display defaults to Output Level Mode when the *DIMMER* module is powered-up. The display will also return to this mode if no buttons are pressed for ten seconds while another mode is selected.

Changing the Display Mode

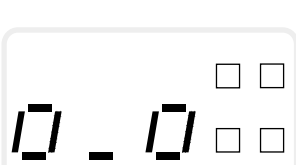
Procedure	Display & Buttons
<p>1. With the display showing Output Level Mode, press and hold the two left-hand buttons.</p> <p>Note: <i>The left-hand buttons show the settings for output CHA; pressing the two right-hand buttons will show the settings for output CHB.</i></p>	
<p>2. After one second approximately, the display will change to the Channel Address Mode.</p> <p>Maintaining pressure on both buttons will cause the display to step through each mode.</p> <p>Dimming Law Mode...</p> <p>Hysteresis Mode...</p> <p>SCENESET Number Mode...</p> <p>Then back to Output Level Mode...</p> <p>Channel Address Mode...etc.</p>	    
<p>3. Releasing the buttons will select the mode currently displayed.</p>	
<p>4. The display can be toggled between the two outputs by momentarily pressing one of the right-hand buttons for CHB, or one of the left-hand buttons for CHA.</p>	
<p>5. If no further buttons are pressed within ten seconds, the display will revert to Output Level Mode.</p>	

OUTPUT LEVEL MODE

In this mode, the display shows the following information:

- Output CHA Level.
- Output CHB Level.
- Operating Status.
- S-DIM Data Line Status.

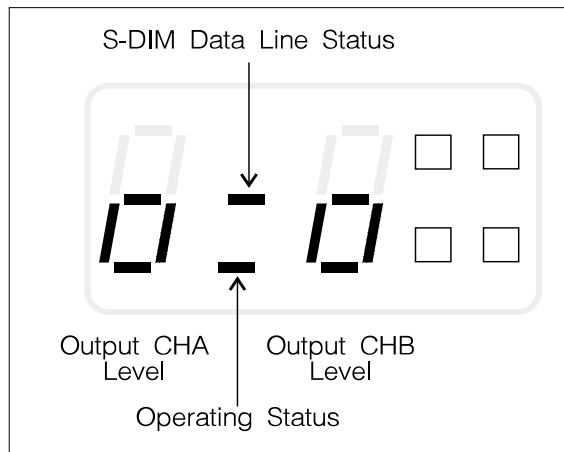

Fig.3-2: Channel level mode display.

Output CHA & CHB Levels

The left-hand digit indicates the level of output CHA, and the right-hand digit indicates the level of CHB.

The level is expressed in terms of percentage control. Note that only the decade (tens) component of the output level is displayed (see Fig.3-3):

Off	1-9%	10-19%	20-29%	30-39%	40-49%	50-59%	60-69%	70-79%	80-89%	90-99%	100%

Fig.3-3: Display conventions for output levels.

Operating Status

When this segment is illuminated in Channel Level Mode, it indicates that the DIMMER module is operating normally.



S-DIM Data Line Status

When the S-DIM data highway is functioning correctly, this segment will blink every time a valid S-DIM message has been received and decoded (approximately every five seconds).

However, even if S-DIM messages are being received, this segment will not blink until the channel addresses have been correctly set (see page 18).

Changing the Output Levels

The output levels will normally be set by the controlling *SCENESET* module. However, to change the levels manually, proceed as follows:

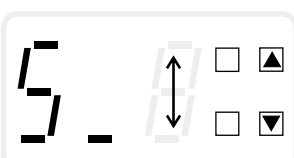
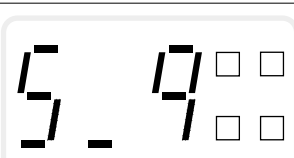
Procedure	Display & Buttons
1. Check that the display is showing Output Level Mode.	
2. To change the level of output CHA, press and hold either the top left-hand button to increase the level or the bottom left-hand button to decrease the level.	
3. When the required level is shown, release the button.	
4. To change the level of output CHB, press and hold either the top right-hand button to increase the level or the bottom right-hand button to decrease the level.	
5. When the required level is shown, release the button.	

SCENESET Control

When the *DIMMER* module is under *SCENESET* control, both output levels are checked periodically against the current scene. If the levels are different (*e.g.* have been changed manually), the *SCENESET* module will return the levels to the correct setting for that scene.

Analogue Control

The output levels for both CHA and CHB can also be set by using the analogue input. For further details, refer to section 4, page 28.

CHANNEL ADDRESS MODE

This mode enables the addresses for outputs CHA and CHB to be defined. The *DIMMER* module supports the following addresses:

- **001 – 128** for use with the *Imagine* Lighting System.
- **129 – 250** these are not currently used, and should not be selected unless otherwise instructed.
- **251 – 254** for use with the *Ambience* Lighting System.
- **255** for use when analogue control only is required.
- **000** for test purposes only.

When the *DIMMER* module is supplied, outputs CHA and CHB are factory-set to addresses 251 and 252 respectively.

IMPORTANT NOTE

The DIMMER module will not respond to S-DIM commands from an Imagine System until the output channel addresses have been correctly set.

Parallel Operation

By setting CHA and CHB to the same address, they will operate in unison. This enables the outputs to be wired in parallel to drive higher loads.





When both outputs are set to the same address, the Dimming Law, Hysteresis, and Level Override settings for CHA are applied to both channels; the settings for CHB are ignored.

Furthermore, if the analogue input is used, then the input for CHA will control both channels; the input for CHB will be ignored.

Control Lock-out

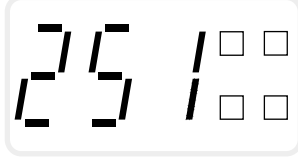
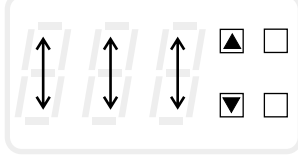
If an address is selected which has been ‘locked’ by the controlling *SCENESET* module, that address cannot be changed again unless the *SCENESET* is reprogrammed or the *DIMMER* module de-powered and the address reset before an S-DIM message is received.

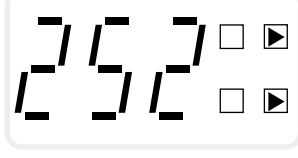
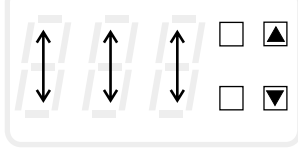
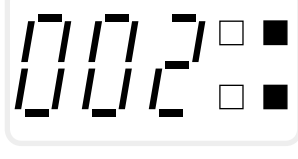
Changing the Channel Addresses

Procedure	Display & Buttons
1. With the display showing Output Level Mode, press and hold the two left-hand buttons.	
2. Wait for the display to change to Channel Address Mode (approximately one second) then release both buttons. <i>Note: The display will show the current address for output CHA.</i>	
3. To change the address, press and hold either the top left-hand button to increase, or the bottom left-hand button to decrease the number. To leave the address as it is, go to step 5.	
4. To store the new address shown, press and hold both left-hand buttons until the display briefly shows '000' to confirm that the new value has been stored in the DIMMER's memory.	
5. To view the address for output CHB, momentarily press either the top or bottom right-hand buttons.	
6. To change the address, press and hold either the top right-hand button to increase, or the bottom right-hand button to decrease the number. To leave the address as it is, go to step 8.	
7. To store the new address shown, press and hold both right-hand buttons until the display briefly shows '000' to confirm the new value has been stored in the DIMMER's memory.	
8. If no further settings need to be changed, release the buttons; the display will revert to Output Level Mode after ten seconds. OR Retain pressure on both buttons until the display changes to the next required mode.	

DIMMING LAW MODE

Both outputs need to be configured to the type of load that they are driving. The *DIMMER* module incorporates nine Dimming Law tables which can be applied separately to each output:

No.	HES92020 & HES92021	HES92220 & HES92221
0	Non-Dimming (for switched loads)	Non-Dimming (for switched loads)
1	Tungsten Linear	Tungsten Linear
2	Tungsten Square	Tungsten Square
3	Tungsten 'S'-Law	Tungsten 'S'-Law
4	2-wire Fluorescent with start pulse	EL TX Limited Range with lamp warm
5	2-wire Fluorescent	EL TX Limited Range
6	Cold Cathode	Tungsten Low Wattage
7	Custom	Custom
8	3-wire Fluorescent	EL TX Limited Range + switched channel



The *DIMMER* module is supplied with both outputs CHA and CHB set to Dimming Law table 1.

Output Characteristics

When table 0 is selected on one channel only, the *DIMMER* module uses different drive characteristics on both outputs. Generally this will not cause any noticeable change on the 'dimming' channel. However, certain capacitive or complex type loads may not respond normally.

Table 8 uses both channel CHA and CHB outputs and must only be selected on CHA for correct operation. When this table is selected, CHA operates using table 5 characteristics, while CHB behaves as a non-dim channel (similar to table 0).

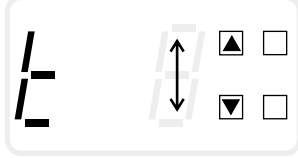
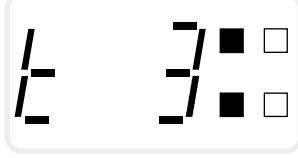
Changing the Dimming Law Table

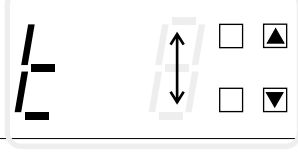
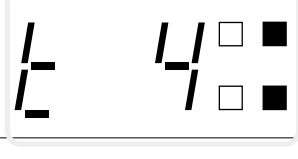
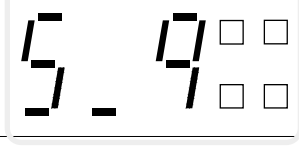
Procedure	Display & Buttons
1. Press and hold the two left-hand buttons until the display shows the Dimming Law Mode. <i>Note: The display will show the current table number for output CHA.</i>	
2. To change the table, press and hold either the top left-hand button to increase, or the bottom left-hand button to decrease the number. To leave the table number as it is, go to step 4.	
3. To store the new table number shown, press and hold both left-hand buttons until the display briefly shows '888' to confirm that the new value has been stored in the DIMMER's memory.	
4. To view the table number for output CHB, momentarily press either the top or bottom right-hand buttons.	
5. To change the table number, press and hold either the top right-hand button to increase, or the bottom right-hand button to decrease the number. To leave the table number as it is, go to step 7.	
6. To store the new table number shown, press and hold both right-hand buttons until the display briefly shows '888' to confirm the new value has been stored in the DIMMER's memory.	
7. If no further settings need to be changed, release the buttons; the display will revert to Output Level Mode after ten seconds. OR Retain pressure on both buttons until the display changes to the next required mode.	

HYSTERESIS MODE (Turn-on/ Turn-off Levels)

This mode is used to set the percentage level at which each output turns on and off (assuming maximum level is 100%). This is referred to as ‘hysteresis’ or as the turn-on and turn-off levels.

The display will show a letter and a two-digit value. The letter indicates the turn-off level and the digits show the turn-on level.

- The turn-on level can be set between 2% and 64% in 2% increments.
- The turn-off level can be set to be either 1% *less than* the turn-on level (display shows the letter ‘r’) or to 80% *of* the turn-on level (display shows the letter ‘h’).

When the *DIMMER* module is supplied, both outputs are set to a turn-on level of 2% with a turn-off level of 1% (as example 1):

Example 1

Turn-on level = 2%.

Turn-off level ‘r’ = (2 - 1)
= 1%.



Example 2





Turn-on level = 50%.

Turn-off level ‘h’ = (50 x 0.8)
= 40%.

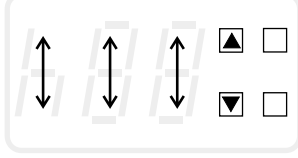

Note: The turn-off level for the ‘h’ setting is calculated to the nearest 0.5%.

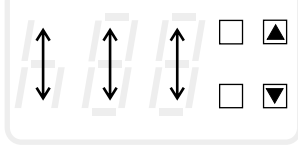
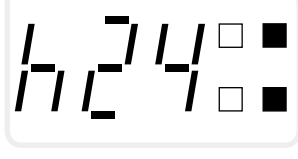
Changing the Turn-on and Turn-off Levels

Procedure	Display & Buttons
<p>1. Press and hold the two left-hand buttons until the display shows the Hysteresis Mode.</p> <p><i>Note: The display will show the current setting for output CHA.</i></p>	
<p>2. To change the setting, press and hold either the top left-hand button to increase, or the bottom left-hand button to decrease the setting.</p> <p><i>Note: The display will cycle through the turn-on levels for '1' and '2' turn-off settings.</i></p> <p>To leave the setting as it is, go to step 4.</p>	
<p>3. To store the new setting shown, press and hold both left-hand buttons until the display briefly shows '888' to confirm that the new value has been stored in the DIMMER's memory.</p>	
<p>4. To view the setting for output CHB, momentarily press either the top or bottom right-hand buttons.</p>	
<p>5. To change the setting, press and hold either the top right-hand button to increase, or the bottom right-hand button to decrease the setting.</p> <p><i>Note: The display will cycle through the turn-on levels for '1' and '2' turn-off settings.</i></p> <p>To leave the setting as it is, go to step 7.</p>	
<p>6. To store the new setting shown, press and hold both right-hand buttons until the display briefly shows '888' to confirm the new value has been stored in the DIMMER's memory.</p>	
<p>7. If no further settings need to be changed, release the buttons; the display will revert to Output Level Mode after ten seconds.</p> <p>OR</p> <p>Retain pressure on both buttons until the display changes to the next required mode.</p>	



SCENESET NUMBER MODE

In a large system, each *DIMMER* module can be connected to one of up to eight *SCENESET* modules.

In this mode, the display will show the number of the controlling *SCENESET* module. This is an advisory display only and cannot be changed.

The display will show the letters 'CH' followed by a number from 1 to 8. If the display shows 'CH0', then there is no *SCENESET* connected.

Checking the *SCENESET* Number

Procedure	Display & Buttons
<p>1. Press and hold the two left-hand buttons until the display shows the <i>SCENESET</i> Number Mode.</p> <p><i>Note: This value is the same for both outputs; pressing the two right-hand buttons will show the same result.</i></p>	
<p>2. The display will revert to Output Level Mode after ten seconds if no buttons are pressed.</p> <p>OR</p> <p>Press and hold the two left-hand buttons until the display changes to the next required mode.</p>	





OUTPUT LEVEL OVERRIDE

Each output can be pre-programmed with an override level. This is the level that will be applied to the output if the *DIMMER* module's Output Level Override circuit is activated. Both outputs CHA and CHB are factory-set to full power (100%), but these can be changed as required.

This function is normally used by the Watchdog facility on the controlling *SCENESET* module.

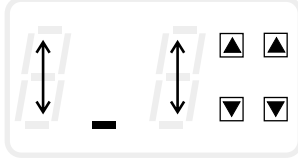
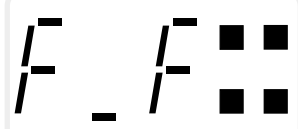
Setting the Override Levels

Whilst each output can have a different override level, both levels have to be set at the same time by the following method:

Procedure	Display & Buttons
1. With the display showing Output Level Mode, adjust the levels of both outputs to the required value (as described on page 17).	
2. When the correct settings are shown, press and hold all four buttons simultaneously until the display briefly flashes '888'.	
3. Release the buttons; the display will revert to Output Level Mode. <i>Note: The levels will remain as just set for Level Override, but may be changed if required.</i>	
4. If the Level Override circuit is now activated, the display will show the programmed levels. Also, vertical bars in the centre of the display will move from side to side. <i>Note: Whilst Level Override is active, the levels for outputs CHA and CHB cannot be changed by the DIMMER module controls.</i>	 

This page is intentionally left blank.

SECTION 4

ANALOGUE CONTROL

This section covers the following topics:

- Control Priority
- Analogue Connector.
- Basic Control Circuit.

ANALOGUE CONTROL

As well as being controlled by the S-DIM data highway, the level of each *DIMMER* output can also be set by a 0 – 10V analogue input.

The control level is directly proportional to the analogue input, e.g. 5V input will give 50% control level, 10V will give 100%, etc.

NOTE *The actual output level obtained for a given control level will depend on the dimming law table selected.*

Control Priority

If a particular output is controlled by both an S-DIM and analogue input, the input which defines the highest output level will take priority.

If the output level is required to respond to analogue input only, then the channel address for that output must be set to '255'. For further details on setting the address, refer to section 3, page 18.

Analogue Connector

This is located on the right-hand side of the *DIMMER* module (see Fig.4-1):

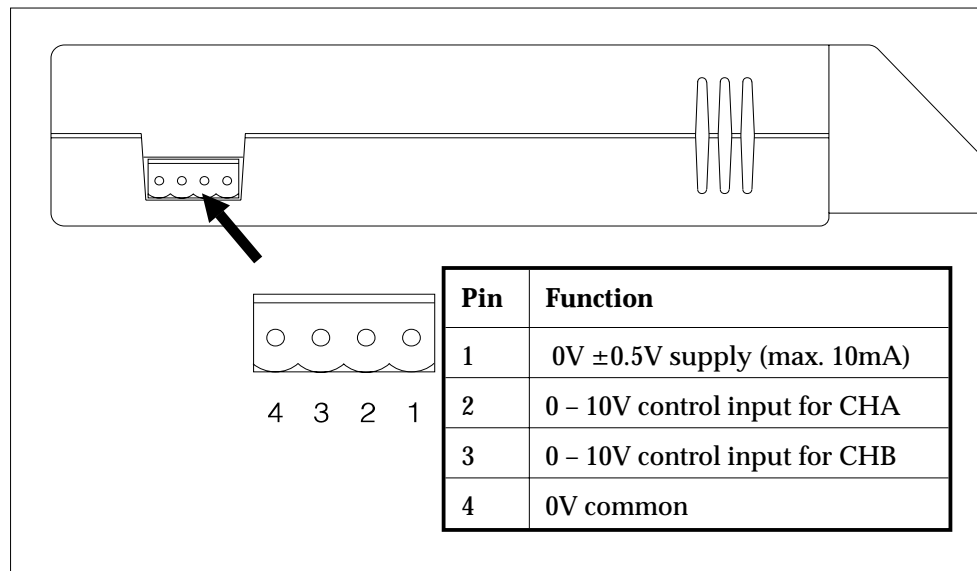

Fig.4-1: Analogue input connector.

Suitable mating connector: Helvar part no. T1704
(not supplied).

Cable size: 0.2 – 2.5mm².

Stripping length: 7mm.

Recommended cable type: Equipment wire.

Maximum cable length: 100m.

Basic Analogue Control Circuit

A typical analogue control circuit is shown in Fig.4-2. Although both inputs are shown as connected, one input only can be used if required.

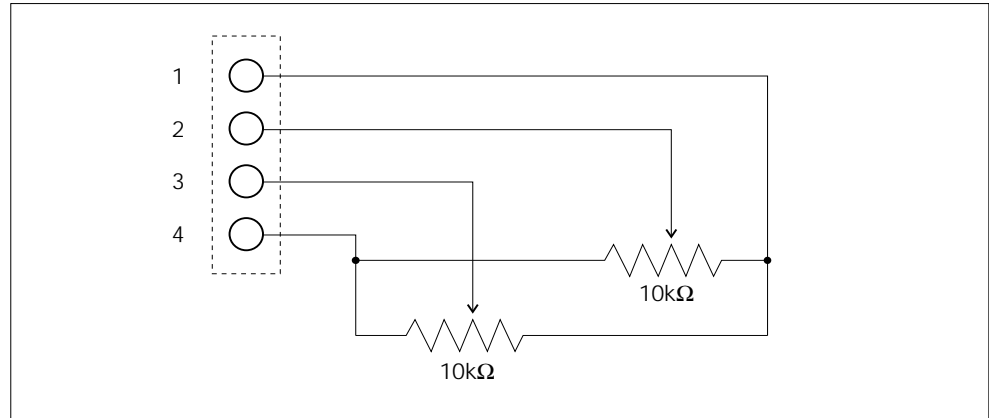

Fig.4-2: Basic analogue control circuit.

This page is intentionally left blank.

SECTION 5

DIMMER TROUBLESHOOTING

This section covers the following topics:

- Diagnostic Codes.
- Problem Diagnosis.

DIAGNOSTIC CODES

Whenever the *DIMMER* module detects an abnormal condition, a flashing diagnostic code will be displayed on the front panel.

The codes fall into three categories:

- 'Fatal'.
- Self-recoverable.
- Communication.

The tables on the following pages list the codes, their likely causes and what action, if any, needs to be taken.

If a diagnostic code is displayed which is not listed, this may indicate an internal fault condition. If this occurs, please call your service agent.

'Fatal' Codes

In the event of a 'Fatal' Code , both outputs of the *DIMMER* module will be automatically turned off (*i.e.* set to zero level). Neither output can be used until the cause has been cleared.

Code	Likely Cause	Action
E03	<p>The mains frequency is not in the range 45–65Hz.</p> <p>The mains supply is 'noisy'.</p> <p>Internal circuit fault.</p>	<p>Turn off the supply to the <i>DIMMER</i> module for a few seconds, then turn back on.</p> <p>If the code recurs, check the mains frequency.</p> <p>If the mains frequency is O.K. but the code recurs, call for service.</p>
E04	<p>Internal circuit fault.</p>	<p>Turn off the supply to the <i>DIMMER</i> module for a few seconds, then turn back on.</p> <p>If the code recurs, call for service.</p>
E07	<p>The internal circuit temperature has exceeded 90C.</p> <p>Internal circuit fault.</p>	<p>Turn off the supply to the <i>DIMMER</i> module <i>immediately</i> and call for service.</p> <p>Warning: Do not turn the supply back on. Internal damage may have resulted from the high temperature.</p>

Self-recoverable Codes

In the event of a Self-recoverable Code the *DIMMER* module will reduce the current on one or both outputs. Output levels cannot be increased until the cause has been cleared.

Code	LikelyCause	Action
E51	<p>The internal circuit temperature has exceeded 70C.</p> <p><i>Note: Both output levels will reduce.</i></p>	<p>Check that all ventilation grilles are free from obstructions.</p> <p>If the module is not being forced-air cooled, check that the load for each output is not exceeding 10A.</p> <p>If the ventilation and loading are O.K., call for service.</p>
E01	<p>Output CHA current has exceeded the maximum of 20A.</p> <p><i>Note: Output CHA level will reduce.</i></p>	<p>Press one of the four buttons on the front of the <i>DIMMER</i> module; the display should clear.</p> <p>If the code does not clear, the associated lighting circuit is probably overloaded.</p>
E02	<p>Output CHB current has exceeded the maximum of 20A.</p> <p><i>Note: Output CHB level will reduce.</i></p>	<p>Press one of the four buttons on the front of the <i>DIMMER</i> module; the display should clear.</p> <p>If the code does not clear, the associated lighting circuit is probably overloaded.</p>
E03	<p>The current through both outputs has exceed the maximum of 20A each.</p> <p><i>Note: Both output levels will reduce.</i></p>	<p>Press one of the four buttons on the front of the <i>DIMMER</i> module; the display should clear.</p> <p>If the code does not clear, the associated lighting circuits are probably overloaded.</p>

Communication Codes

These are advisory codes and will not usually change the current status of the *DIMMER* module. However, subsequent S-DIM or control panel commands may be ignored until the code has been cleared.

Code	Likely Cause	Action
E50	Data corruption in S-DIM message.	The S-DIM message is ignored. The condition should clear automatically after ten seconds.
E52	Error in S-DIM message.	The S-DIM message is ignored. The condition should clear automatically after ten seconds.
E53	Noise detected in S-DIM message.	The S-DIM message is ignored. The condition should clear automatically after ten seconds.
E54	General error in S-DIM communications link.	The S-DIM message is ignored. The condition should clear automatically after ten seconds.
E55	Front panel switch 'stuck on'.	Call for service.
E56	Checksum error in S-DIM message.	The S-DIM message is ignored. The condition should clear automatically after ten seconds.

Repeated problems with the S-DIM data highway are most likely to be caused by bad connections, data cables running through electrically 'noisy' environments or incorrect configuration of other devices in the system.

If further advice is needed, contact the system installer or service agent.

PROBLEM DIAGNOSIS

If the *DIMMER* module fails to operate as expected, it is more likely to be the result of incorrect setting-up and configuration than a fault with the module itself. Alternatively, there may be a problem elsewhere in the system.

Before calling for service, check through the following list of problems and likely causes:

Problem	Likely Cause & Remedy
Display is blank.	No power to power input LA. Check appropriate MCB or fuse.
Output CHA or CHB will not dim – will only change between zero and full power.	Dimming Law Table 0 (non-dim) is selected (see section 3, page 20).
Output loads not dimming correctly.	Wrong Dimming Law selected for the load type (see section 3, page 20). Hysteresis set incorrectly (see section 3, page 22).
Output CHA or CHB not responding to S-DIM control.	Channel Addresses not correctly set (see section 3, page 18). Incorrect or faulty connections on the S-DIM data line. Check that the rear connector is fully seated on to the <i>STACKER</i> motherboard. <i>DIMMER</i> module is not connected to a <i>SCENESET</i> (see section 3, page 24).
Channel Address cannot be changed by the front panel controls.	The Channel Address is 'locked-out' by the <i>SCENESET</i> module.
A <i>DIMMER</i> parameter cannot be changed by front panel controls. When current setting is viewed, the display flashes.	The parameter is 'locked-out' by the <i>SCENESET</i> module.

HELVAR Merca Ltd.
Hawley Mill
Hawley Road
Dartford, Kent. DA2 7SY
United Kingdom.

Telephone: +44 (0)1322 222211.
Facsimile: +44 (0)1322 282216.

HELVAR

The logo for HELVAR, featuring the word "HELVAR" in a bold, black, serif font. The letters are thick and closely spaced. Below the text is a solid black horizontal bar that spans the width of the word.

Part No. I434GB issue 2
