

## 50 W Dimmable LED driver with Active+ / ActiveAhead functionality

50 W 220 – 240 V 0 / 50 – 60 Hz

- Fully automatic standalone setup with smart learning functionality
- Optimised presence detection, daylight harvesting and Constant Lumen Output (CLO) operation
- No programming, configuration, or external control wiring needed
- Driver protection Class II (built-in)
- Suitable for Class I and Class II luminaires
- Suitable for driving Class III luminaires as independent controlgear, when optional strain relief (LC1x70-SR) is used
- Fully automatic standalone setup with smart learning functionality for stairway

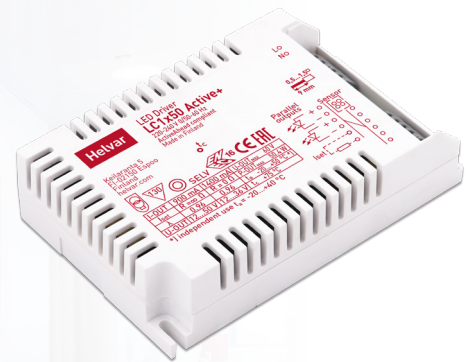

### Functional Description

- Adjustable constant current output via external resistors: 900 mA (default) to 1400 mA
- Hybrid dimming technique for high quality light
- Adaptive LED overload protection. Reduces output current if overload of up to 52 V is detected
- Full load recognition, underload protection, open and short circuit protection
- ON level: fully automatic Constant Lumen Output. Dynamic operational area between ON level and energy saving level
- Occupancy timeout: 3.5 min, fadetime to energy saving level: 1.5 min
- Lighting experience in ActiveAhead according to predicted people flow
- Customization of luminaire parameters through use of Helvar Active+ / ActiveAhead mobile apps (see User Guide)
- Inbuilt power supply for sensor use

### Mains Characteristics

Voltage range	198 VAC – 264 VAC
DC range	176 VDC - 280 VDC
starting voltage	> 190 VDC
Mains current at full load	0.22 A – 0.31 A
Frequency	0 / 50 Hz – 60 Hz
Stand-by power consumption	< 0.4 W
THD at full power	< 15 %
Tested surge protection	1 kV L-N, 2 kV L-GND (IEC 61000-4-5)
Tested fast transient protection	4 kV (IEC 61000-4-4)

### Insulation between circuits & driver case

Mains circuit - SELV output circuit	Double/reinforced insulation
Mains and output - Driver case	Double/reinforced insulation

### Load Output (SELV <60 V)

Output current ( $I_{out}$ )	900 mA (default) – 1400 mA
Accuracy	± 5 %
Ripple	< 2 %* at ≤ 120 Hz
	<small>*) Low frequency, LED load: Cree XM-L LEDs</small>
$U_{out}$ (max) (abnormal)	60 V

$I_{out}$	900 mA	1400 mA
$P_{out}$ (max)	45 W	50.4 W
$U_{out}$	12 V - 50 V	12 V – 36 V
PF ( $\lambda$ ) at full load	0.96	0.96
Efficiency ( $\eta$ ) at full load	88 %	87 %

Operating window

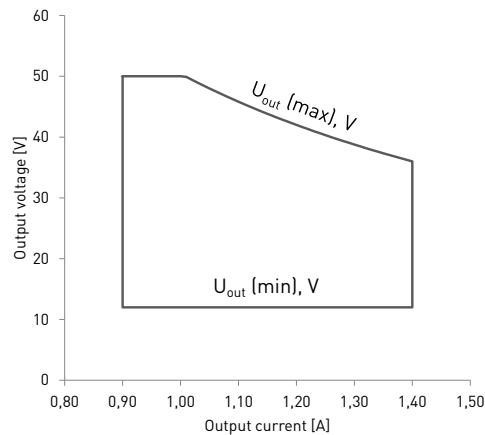

Hybrid dimming technique in automatic dimming

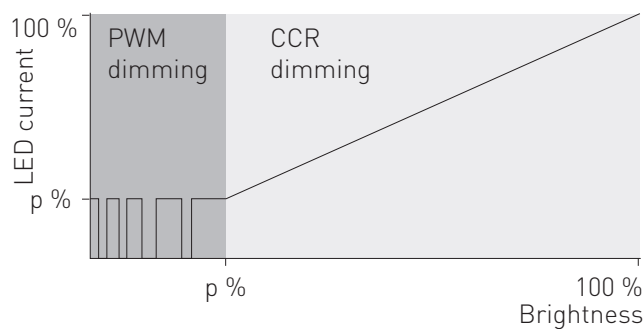

Dimming range	Dimming technique
1 % – 20 %	Pulse Width Modulation (PWM)*
20 % – 100 %	Constant Current Reduction (CCR)

\* PWM dimming frequency 1250 Hz

Driver performance

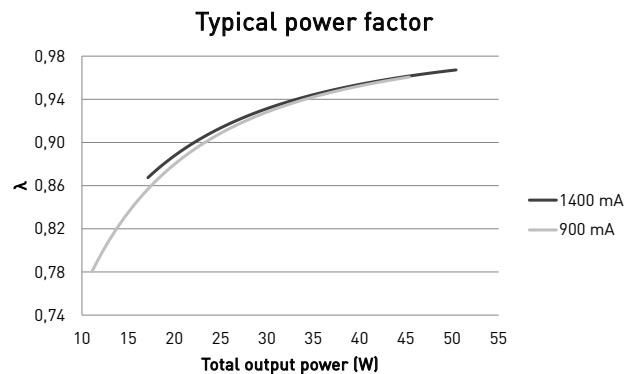
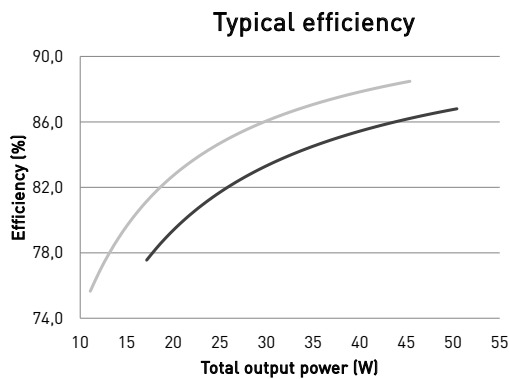

Operating Conditions and Characteristics

Highest allowed $t_c$ point temperature	75 °C
Ambient temperature range in independent use	-20 °C ... +50 °C
Storage temperature range	-20 °C ... +40 °C
Maximum relative humidity	-40 °C ... +80 °C
Life time (90 % survival rate)	No condensation
	100 000 h, at $t_c = 65$ °C
	70 000 h, at $t_c = 70$ °C
	50 000 h, at $t_c = 75$ °C

Quantity of drivers per miniature circuit breaker 16 A Type C

Based on $I_{cont}$	Based on inrush current $I_{peak}$	Typ. peak inrush current $I_{peak}$	1/2 value time, $\Delta t$	Calculated energy, $I_{peak}^2 \Delta t$
43 pcs.	61 pcs.	29 A	146 $\mu$ s	0.097 A <sup>2</sup> s

## Connections and Mechanical Data

Wire size	0.5 mm <sup>2</sup> – 1.5 mm <sup>2</sup>
Wire type	Solid core and fine-stranded
Wire insulation	According to EN 60598
Maximum driver to LED wire length	5 m
Weight	172 g
IP rating	IP20

## Connections

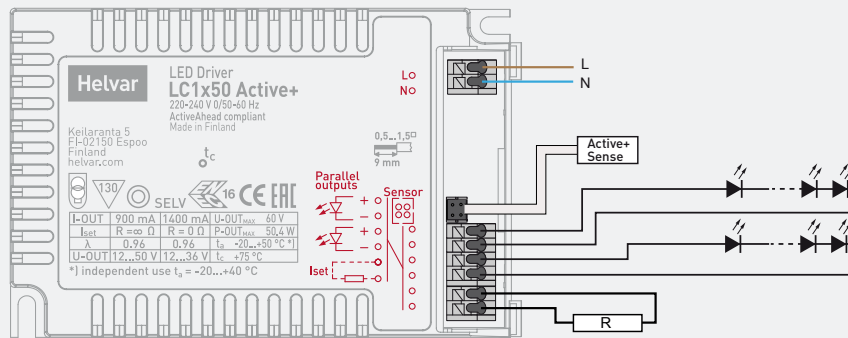

Note:

- Not suitable for load side switching operation.
- LC1x50 Active+ has Iset terminal, however it is compatible with LED-Iset resistor values according to the table below.

## Dimensions (mm)

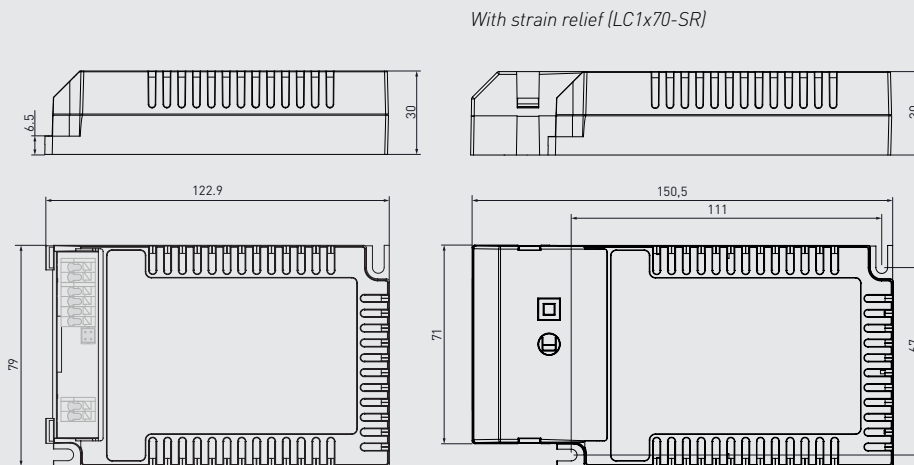

The current setting values are adjusted according to the LEDset specification. The resistor value for each required output current can thus be calculated from the formula  $R [\Omega] = (5 [V] / I_{out} [A]) * 1000$ . Below are the available LED-Iset resistors from Helvar, pre-adjusted for the most common output currents.

## Helvar LED-Iset resistors and currents (Nominal $I_{out}$ (±5 % tol.))

LED-Iset resistor model	MAX	1350 mA	1300 mA	1250 mA	1200 mA	1150 mA	1100 mA	1050 mA	1000 mA	950 mA	No resistor
$I_{out}$ (mA)	1400	1350	1300	1250	1200	1150	1100	1050	1000	950	900
Order code	T90000	T91350	T91300	T91250	T91200	T91150	T91100	T91050	T91000	T90950	N/A
Resistance values ( $\Omega$ )	0	3.74k	3.83k	4.02k	4.12k	4.32k	4.53k	4.75k	4.99k	5.23k	$\infty$

The current can be adjusted also with normal resistors by selecting suitable resistor value (formula  $R [\Omega] = (5 [V] / I_{out} [A]) * 1000$ ). Reference resistor values can be found below order code in the table above.

LC1x50 Active+ LED driver is suited for built-in usage in luminaires. In order to have safe and reliable LED driver operation, the LED luminaires will need to comply with the relevant standards and regulations (e.g. IEC/EN 60598-1). The LED luminaire shall be designed to adequately protect the LED driver from dust, moisture and pollution. The luminaire manufacturer is responsible for the correct choice and installation of the LED drivers according to the application and product datasheets. Operating conditions of the LED driver may never exceed the specifications as per the product datasheet.

## Installation & operation

### Maximum $t_c$ temperature:

- Reliable operation and lifetime is only guaranteed if the maximum  $t_c$  point temperature is not exceeded under the conditions of use.
- Ensure that the  $t_c$  point temperature does not rise higher than specified on the product datasheets.

### Installation site:

- The general preferred installation position of LED drivers for independent use is to have the top cover facing upwards.

### Current setting resistor

LC1x50 Active+ LED driver features an adjustable constant current output.

- An external resistor can be inserted in to the current setting terminal, allowing the user to adjust the LED driver output current
- When no external resistor is connected, then the LED drivers will operate at their default lowest current level
- A standard through-hole resistor can be used for the current setting. To achieve the most accurate output current it is recommended to select a quality low tolerance resistor. Minimum diameter for resistor leg is 0.51mm
- Always connect the current setting resistor only into the terminals marked with  $I_{set}$  on the LED driver label.
- Resistor values follow LEDset specification and are presented on page 3

## Lamp failure functionality

### No load

When open load is detected, driver will go to standby. Automatic recovery is on during the first 10 minutes. If open load is still detected after the first 10 minutes, driver goes to standby mode and recovers through mains reset.

### Short circuit

When short circuit is detected, driver goes to standby mode and returns through mains reset.

### Overload

When high over load is detected, driver goes to standby mode and follows the same logic as described in the short circuit condition. When low over load is detected ( $\leq 52$  V), output current will be reduced to have maximum rated output power.

### Underload

When under voltage is detected, driver goes to standby mode and returns through mains reset.

## Conformity & standards

General and safety requirements	EN 61347-1: 2008+ A1:2011+A2:2013
Particular safety requirements for DC or AC supplied electronic control gear for LED modules	EN 61347-2-13: 2014
Thermal protection class	EN 61347, C5e
Mains current harmonics	EN 61000-3-2: 2014
Limits for voltage fluctuations and flicker	EN 61000-3-3: 2013
Radio frequency interference	EN 55015: 2013
Immunity standard	EN 61547: 2009
Performance requirements	EN 62384: 2006+ A1:2009
Independent usage acc. to relevant clauses of	EN 60598-1 : 2015
Compliant with relevant EU directives	
RoHS / REACH compliant	
ENEC and CE marked	

## Label symbols



Thermally controlled control gear, incorporating means of protection against overheating to prevent the case temperature under any conditions of use from exceeding 130 °C.



Safety isolating control gear with short circuit protection (SELV control gear).



Double insulated control gear suitable for built-in use.