

35 W **Dimmable** LED driver with Active+ / ActiveAhead functionality

35 W 220 – 240 VAC 50 – 60 Hz

- Fully automatic standalone setup with smart learning functionality
- Optimised presence detection, daylight harvesting and Constant Lumen Output (CLO) operation
- No programming, configuration, or external control wiring needed
- Suitable for class I and class II luminaires
- Optional strain relief for independent use outside of luminaire (LC1x30-SR)

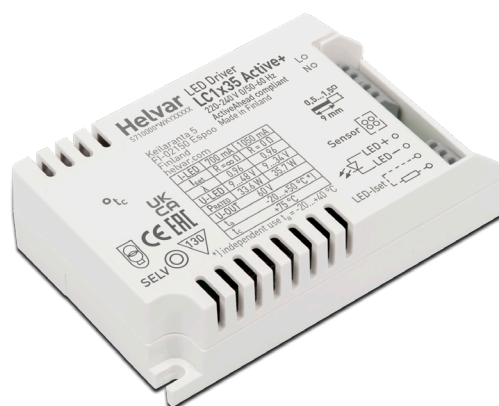

Functional Description

- Adjustable constant current output via external resistors: 700 mA (default) to 1050 mA
- Hybrid dimming technique for high quality light
- Adaptive LED overload protection. Reduces output current if overload of 1 - 4 V is detected
- Full load recognition, open and short circuit protection
- ON level: fully automatic Constant Lumen Output. Dynamic operational area between ON level and energy saving level
- Occupancy timeout: 3.5 min, fadetime to energy saving level: 1.5 min
- Lighting experience in ActiveAhead according to predicted people flow
- Customization of luminaire parameters through use of Helvar Active+ mobile app (see User Guide)
- Inbuilt power supply for sensor use

Mains Characteristics

Voltage range	198 VAC – 264 VAC
DC range	176 VDC - 280 VDC
starting voltage	> 190 VDC
Mains current at full load	0.17 A – 0.19 A
Frequency	0 / 50 Hz – 60 Hz
Stand-by power consumption	0.42 W
THD at full power	< 15 %
Tested surge protection	1 kV L-N, 2 kV L-GND (IEC 61000-4-5)
Tested fast transient protection	2 kV (IEC 61000-4-4)

Insulation between circuits

Mains circuit - SELV circuit	Double/reinforced insulation
------------------------------	------------------------------

Load Output (SELV <60 V)

Output current (I_{out})	700 mA (default) – 1050 mA
Accuracy	± 5 %
Ripple	< 2 %*, at ≤ 120 Hz
	*) Low frequency, LED load: Cree XM-L LEDs
PstLM	< 1
SVM	< 0.4*
	*) At full load
U_{out} (max) (abnormal)	60 V

	700 mA	1050 mA
I_{out}	700 mA	1050 mA
P_{out} (max)	33.6 W	35.7 W
U_{out}	9 V – 48 V	9 V – 34 V
λ at full power	0.96	0.96
Efficiency (η), max load	0.89	0.88

Operating window

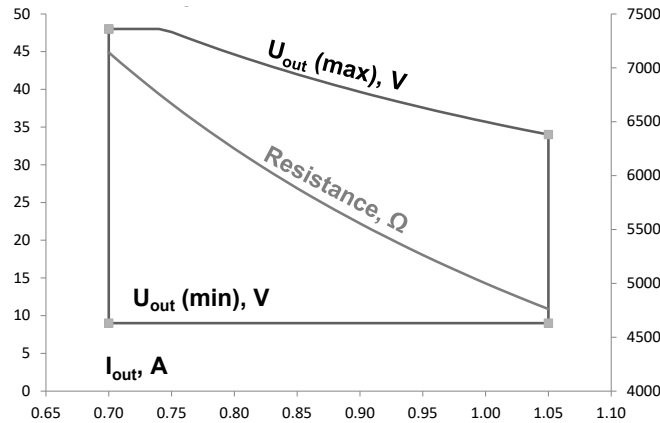

Hybrid dimming technique in automatic dimming

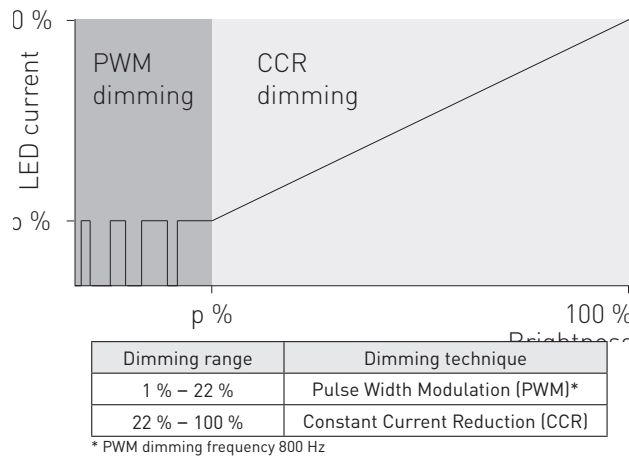

Driver performance

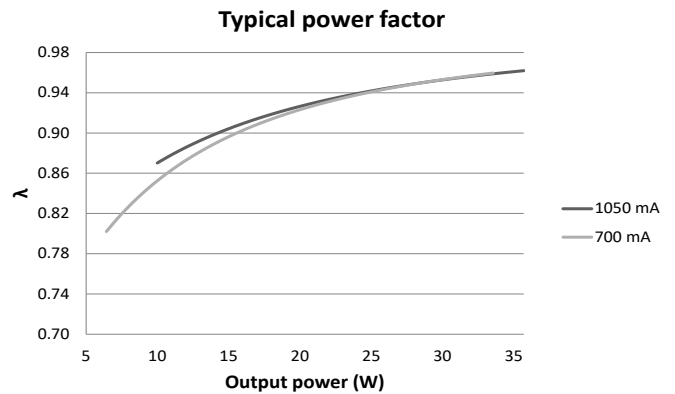
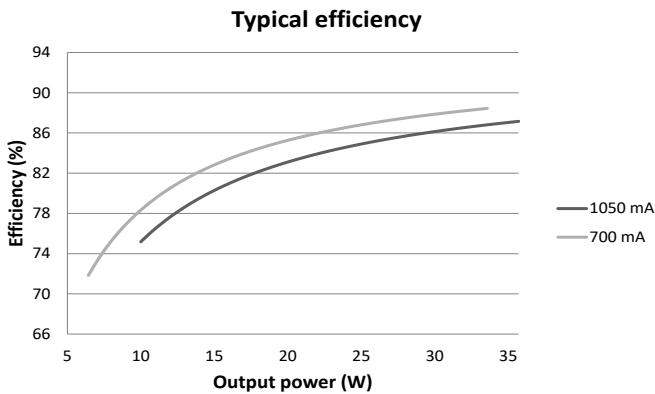

Operating Conditions and Characteristics

Highest allowed t_c point temperature	75 °C
Ambient temperature range	-20 °C ... +50 °C
in independent use	-20 °C ... +40 °C
Storage temperature range	-40 °C ... +80 °C
Maximum relative humidity	No condensation
Life time (90 % survival rate)	100 000 h, at $t_c = 65$ °C
	90 000 h, at $t_c = 70$ °C
	60 000 h, at $t_c = 75$ °C

Quantity of drivers per miniature circuit breaker 16 A Type C

Based on I_{cont}	Based on I_{peak}	Typ.inrush current	1/2 value time, Δt	Calculated energy, $I_{peak}^2 \Delta t$
53 pcs.	86 pcs.	25 A	177 μs	0.08 A ² s

Connections and Mechanical Data

Wire size	0.5 mm ² – 1.5 mm ²
Wire type	Solid core and fine-stranded
Wire insulation	According to EN 60598
Maximum driver to LED wire length	5 m
Weight	117 g
IP rating	IP20

Connections

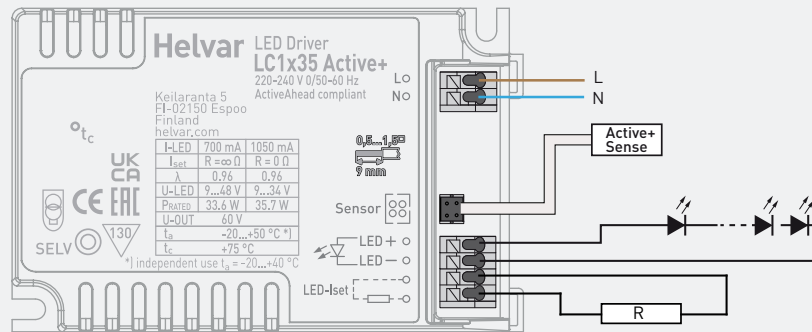

Note:

- Not suitable for load side switching operation.
- LC1x35 Active+ has Iset terminal, however it is compatible with LED-Iset resistor values according to the table below.

Dimensions (mm)

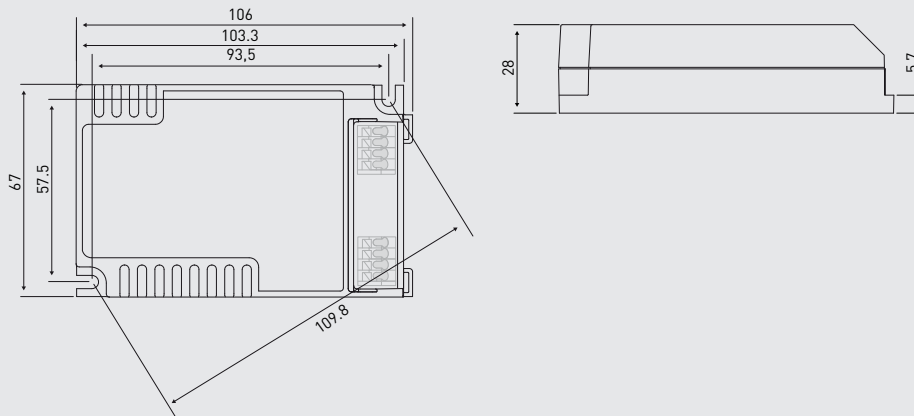

The current setting values are adjusted according to the LEDset specification. The resistor value for each required output current can thus be calculated from the formula $R [\Omega] = (5 [V] / I_{out} [A]) * 1000$. Below are the available LED-Iset resistors from Helvar, pre-adjusted for the most common output currents.

Helvar LED-Iset resistors and currents (Nominal $I_{out} (\pm 5\% \text{ tol.})$)

LED-Iset resistor model	MAX	1000 mA	950 mA	900 mA	850 mA	800 mA	750 mA	No resistor
I_{out} (mA)	1050	1000	950	900	850	800	750	700
Order code	T90000	T91000	T90950	T90900	T90850	T90800	T90750	N/A
Resistance values (Ω)	0	4.99k	5.23k	5.6k	5.90k	6.20k	6.65k	∞

The current can be adjusted also with normal resistors by selecting suitable resistor value (formula $R [\Omega] = (5 [V] / I_{out} [A]) * 1000$). Reference resistor values can be found below order code in the table above.

LC1x35 Active+ LED driver is suited for inbuilt luminaire usage. In order to have safe and reliable LED driver operation, the LED luminaires will need to comply with the relevant standards and regulations (e.g. IEC/EN 60598-1). The LED luminaire shall be designed to adequately protect the LED driver from dust, moisture and pollution. The luminaire manufacturer is responsible for the correct choice and installation of the LED drivers according to the application and product datasheets. Operating conditions of the LED driver may never exceed the specifications as per the product datasheet.

Installation & operation

Maximum t_c temperature:

- Reliable operation and lifetime is only guaranteed if the maximum t_c point temperature is not exceeded under the conditions of use.
- Ensure that the t_c point temperature does not rise higher than specified on the product datasheets.

Installation site:

- The general preferred installation position of LED drivers for independent use is to have the top cover facing upwards.

Current setting resistor

LC1x35 Active+ LED driver features an adjustable constant current output.

- An external resistor can be inserted in to the current setting terminal, allowing the user to adjust the LED driver output current.
- When no external resistor is connected, then the LED drivers will operate at their default lowest current level.
- A standard through-hole resistor can be used for the current setting. To achieve the most accurate output current it is recommended to select a quality low tolerance resistor. Minimum diameter for resistor leg is 0.51mm.
- Always connect the current setting resistor only into the terminals marked with I_{set} on the LED driver label.
- Resistor/current values are presented on page 3.

Lamp failure functionality

No load

When open load is detected, driver will go to standby. Automatic recovery is on during the first 10 minutes. If open load is still detected after the first 10 minutes, driver goes to standby mode and recovers through mains reset.

Short circuit

When short circuit is detected, driver goes to standby mode and returns through mains reset.

Overload

When high over load is detected, driver goes to standby mode and follows the same logic as described in the short circuit condition. When low over load is detected, output current will be reduced to have maximum rated output power.

Underload

When under voltage is detected, driver goes to standby mode and returns through mains reset.

Conformity & standards

General and safety requirements	EN61347-1
Particular safety requirements for DC or AC supplied electronic control gear for LED modules	EN61347-2-13
Thermal protection class	EN61347, C5e
Mains current harmonics	EN61000-3-2
Limits for voltage fluctuations and flicker	EN61000-3-3
Radio frequency interference	EN55015
Immunity standard	EN61547
Performance requirements	EN62384
Independent usage acc. to relevant clauses of	EN60598-1
Compliant with relevant EU directives	
CE / UKCA marked	

Company Address:
Helvar Oy Ab
 Keilaranta 5
 FI-02150, Espoo