

## 42 W SELV constant current LED driver

Product code: 5919

42 W 220 – 240 V 50 – 60 Hz

- SELV output protection for safety and flexibility in luminaires
- Low current ripple, complying with IEEE 1789 recommendation
- Extremely compact dimensions for flexible usage
- Ideal solution for Class I and Class II luminaires
- For driving Class III (SELV) luminaires, optional strain relief for independent use outside of luminaire (LC-SR-MINI)

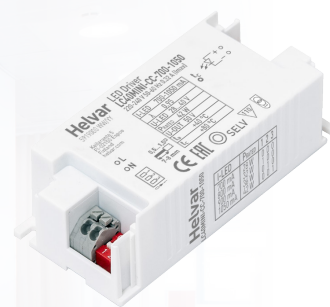

### Functional Description

- Adjustable constant current output: 700 mA to 1050 mA (default)
- Current setting via dip-switches
- Overload, open & short circuit protection

### Mains Characteristics

Nominal rated voltage range	220 V – 240 V, 50 – 60 Hz
AC voltage range	198 VAC – 264 VAC
DC voltage range	198 VDC – 280 VDC
Mains current at full load	0.32 A
Frequency	50 Hz – 60 Hz
Stand-by power consumption	< 0.5 W
THD at full power	< 10 %
Tested surge protection	1 kV kV L-N (IEC 61000-4-5) 2 kV kV L/N-GND (IEC 61000-4-5)
Tested fast transient protection	1 kV kV (IEC 61000-4-4)

### Insulation between circuits & driver case

Mains circuit - SELV circuit	Double/reinforced insulation
Mains and output - Driver case	Double/reinforced insulation

### Load Output (SELV <60 V)

Output current ( $I_{out}$ )	700 mA – 1050 mA (default)
Accuracy	$\pm 5 \%$
Ripple	< 2 %* at $\leq 120$ Hz
	*] Low frequency
$U_{out}$ (max) (abnormal)	50 V

	700 mA	1050 mA
$I_{LED}$	700 mA	1050 mA
$P_{Rated}$	28 W	42 W
$U_{LED}$	28–40 V	28–40 V
PF ( $\lambda$ ) at full load	0.95	0.95
Efficiency ( $\eta$ ) at full load	> 87 %	> 87 %

## Operating window

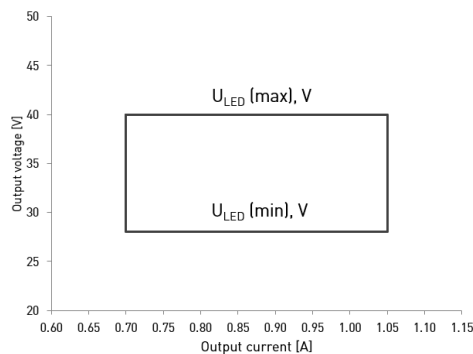

Current value is adjustable in steps via dip-switch. See dip-switch settings in page 3 for details.

## Driver performance

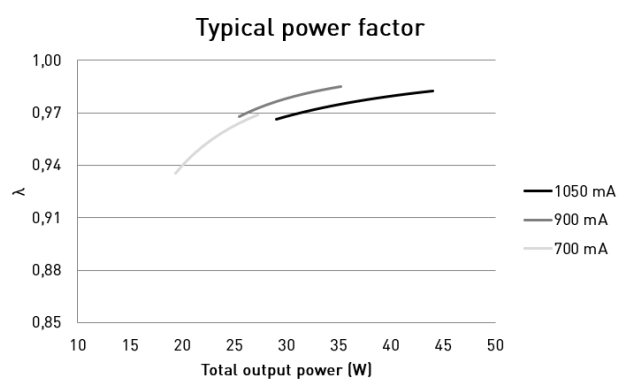
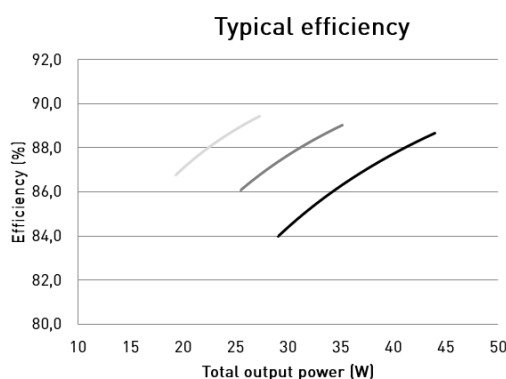

## Operating Conditions and Characteristics

Absolute highest allowed $t_c$ point temperature	80 °C
$T_c$ life (50 000 h) temperature	75 °C
Ambient temperature range*	-20 °C .. +40 °C*
Storage temperature range	-40 °C .. +80 °C*
Maximum relative humidity	No condensation
Life time (90 % survival rate)	50 000 h, at $t_c = 75$ °C 30 000 h, at $t_c = 80$ °C

\*) For other than independent use, higher  $t_a$  of the controlgear possible as long as highest allowed  $t_c$  point temperature is not exceeded

## Quantity of drivers per miniature circuit breaker 16 A Type C

Based on inrush current $I_{peak}$	Typ. peak inrush current $I_{peak}$	1/2 value time, $\Delta t$
37 pcs.	30 A	200 $\mu$ s

### CONVERSION TABLE FOR OTHER TYPES OF MINIATURE CIRCUIT BREAKER

MCB type	Relative quantity of LED drivers
B 10 A	37 %
B 16 A	60 %
B 20 A	75 %
C 10 A	62 %
C 16 A	100 % (see table above)
C 20 A	125 %

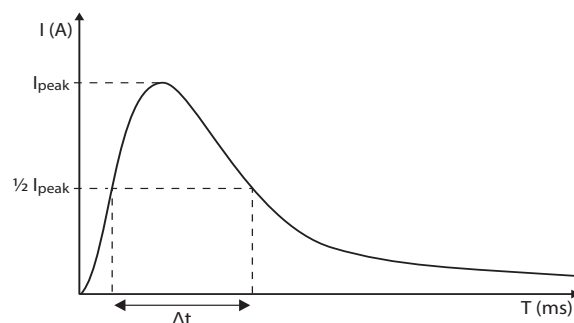

## CONTINUOUS CURRENT

Total continuous current of the drivers and installation environment must always be considered and taken into calculations when installing drivers behind miniature circuit breaker. Example calculation of total drivers amount limited by continuous current:  $n(I_{cont}) = (16 A (I_{nom,Ta}) / \text{"nominal mains current with full load"}) \times 0.76$ . This calculation is an example according to recommended precautions due to multiple adjacent circuit breakers (> 9 MCBs) and installation environment ( $T_a$  30 degrees); variables may vary according to the use case. Both inrush current and continuous current calculations are based on ABB S200 series circuit breakers. More specific information in ABB series S200 circuit breaker documentation.

NOTE! Type C MCB's are strongly recommended to use with LED lighting. Please see more details in "MCB information" document in each driver product page in "downloads & links" section.

## Connections and Mechanical Data

Wire size	0.5 mm <sup>2</sup> – 1.5 mm <sup>2</sup>
Wire type	Solid core and fine-stranded
Wire insulation	According to EN 60598
Maximum driver to LED wire length	1.5 m
Weight	129 g
IP rating	IP20

## Connections

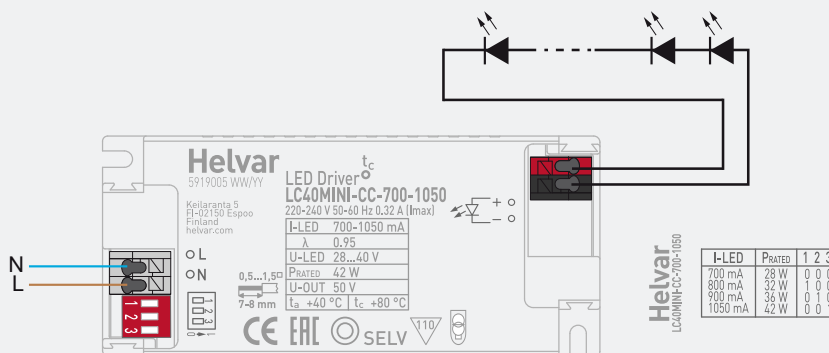

Note:

- Not suitable for load side switching operation

## Dimensions (mm)

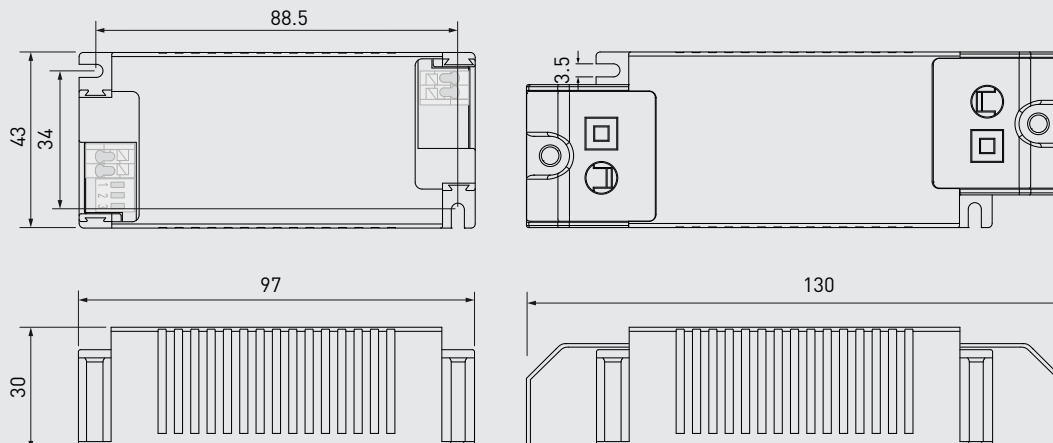

In LC40MINI-CC-700-1050, the current can be set with dip-switches. With each combination of switch setup, a different output current value can be set. The maximum value can be reached with the dip-switch setting presented below and minimum with all switches set to "0" (pushed away from the label, see connections picture above). The output current values according to the dip-switch settings are presented below.

### Dip-switch combinations, output currents and voltage ranges (Nominal I<sub>out</sub> (±5 % tol.))

Dip-Switch combination	000	100	010	001
I <sub>out</sub> (mA)	700	800	900	1050
Voltage range	28 - 40 V	28 - 40 V	28 - 40 V	28 - 40 V

LC40MINI-CC-700-1050 LED driver is suited for built-in usage in luminaires. With external strain relief (LC-SR-MINI), independent use is possible too. In order to have safe and reliable LED driver operation, the LED luminaires will need to comply with the relevant standards and regulations (e.g. IEC/EN 60598-1). The LED luminaire shall be designed to adequately protect the LED driver from dust, moisture and pollution. The luminaire manufacturer is responsible for the correct choice and installation of the LED drivers according to the application and product datasheets. Operating conditions of the LED drivers may never exceed the specifications as per the product datasheet.

## Installation & operation

### Maximum ambient and $t_c$ temperature:

- For built-in components inside luminaires, the  $t_a$  ambient temperature range is a guideline given for the optimum operating environment. However, integrator must always ensure proper thermal management (i.e. mounting base of the driver, air flow etc.) so that the  $t_c$  point temperature does not exceed the  $t_c$  maximum limit in any circumstance.
- Reliable operation and lifetime is only guaranteed if the maximum  $t_c$  point temperature is not exceeded under the conditions of use.

### Current setting via dip-switch

LC40MINI-CC-700-1050 LED driver features a constant current output adjustable via dip-switch combinations

- For the combination/current values, refer to the table on page 3.
- Only the dip-switch settings presented in the table shall be used.

### Miniature Circuit Breakers (MCB)

- Type-C MCB's with trip characteristics in according to EN 60898 are recommended.
- Please see more details in "MCB information" document in each driver product page in "downloads & links" section.

### Installation site

- The general preferred installation position of LED drivers for independent use is to have the top cover facing upwards.

## Lamp failure functionality

### No load

When open load is detected, driver limits output voltage according to  $U_{out} (max)$  (abnormal).

### Overload

The driver can withstand output overload.

### Short circuit

Driver can withstand output short circuit and after resolving the fault, driver recovers normal operation automatically.

## Conformity & standards

General and safety requirements	EN 61347-1: 2015
Particular safety requirements for DC or AC supplied electronic control gear for LED modules	EN 61347-2-13: 2014+ A1:2017
Mains current harmonics	EN 61000-3-2: 2014
Limits for voltage fluctuations and flicker	EN 61000-3-3: 2013
Radio frequency interference	EN 55015: 2013+ A1: 2015
Immunity standard	EN 61547: 2009
Performance requirements	EN 62384: 2006+ A1:2009
Recommended Practices for Modulating Current in High-Brightness LEDs for Mitigating Health Risks to Viewers	IEE1789 - 2015
Compliant with relevant EU directives	
RoHS/REACH compliant	
CE marked	

## Label symbols



Safety isolating control gear with short circuit protection (SELV control gear).



Double insulated control gear suitable for built-in use.



Thermally controlled control gear, incorporating means of protection against overheating to prevent the case temperature under any conditions of use from exceeding 110 °C.