

44.1 W SELV Dimmable DALI-2 LED driver

Product code: 5921

44.1 W 220 – 240 V 50 – 60 Hz

- DALI-2 certified LED driver, 1-100 % dimming range
- SELV output protection for safety and flexibility in luminaires
- Amplitude dimming for the highest quality light output
- Low current ripple, complying with IEEE 1789 recommendation
- Suitable for DC use
- Extremely compact dimensions for flexible usage
- Ideal solution for Class I and Class II
- For driving Class III (SELV) luminaires, optional strain relief for independent use outside of luminaire (LC-SR-MINI)

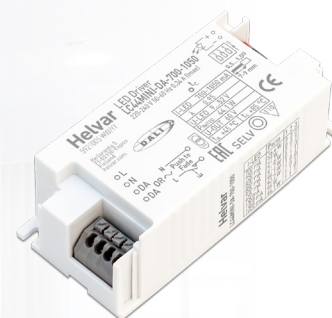

Functional Description

- Adjustable constant current output: 700 mA to 1050 mA (default)
- Current setting via with dip-switches
- Amplitude dimming technology for the highest quality light in every application
- Push to Fade functionality for easy-to-use intensity control with smooth fade in transitions*
- Suitable for flicker-free camera recording applications
- Overload, open & short circuit protection

*Available since revision B

Mains Characteristics

Nominal rated voltage range	220 V – 240 V, 50 – 60 Hz
AC voltage range	198–264 VAC
DC voltage range	176–280 VDC
Mains current at full load	0.34 A
Frequency	50 Hz – 60 Hz
Stand-by power consumption	< 0.5 W
THD at full power	< 10%
Tested surge protection	1 kV kV L/N-GND (IEC 61000-4-5) 2 kV kV L-N (IEC 61000-4-5)
Tested fast transient protection	1 kV kV (IEC 61000-4-4)

Insulation between circuits & driver case

Mains circuit - SELV circuit	Double/reinforced insulation
DALI circuit - SELV circuit	Double/reinforced insulation
Mains circuit - DALI circuit	Basic insulation
Mains, DALI and output - Driver case	Double/reinforced insulation

Load Output (SELV <60 V)

Output current (I_{out})	700 mA – 1050 mA (default)
Accuracy	± 5 %
Ripple	<± 3 %* at ≤ 120 Hz
U_{out} (max) (abnormal)	60 V

*] Low frequency, LED load: Cree XP-G LEDs

I_{LED}	700 mA	1050 mA
P_{Rated}	36.4 W	44.1 W
U_{LED}	9–52 V	9–42 V
PF (λ) at full load	0.95	0.95
Efficiency (η) at full load	> 85 %	> 87 %

Operating window

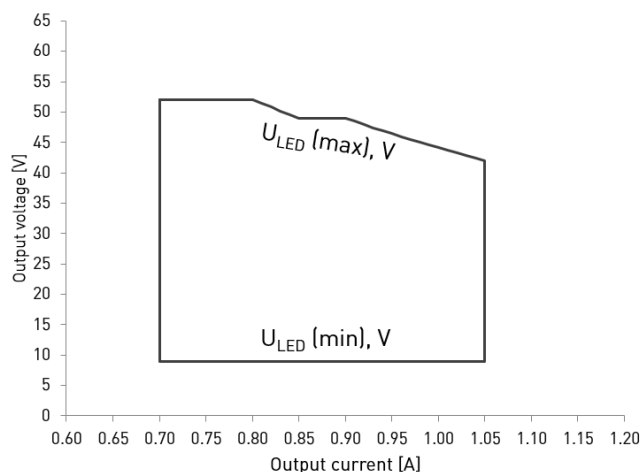

Note: Current value is adjustable in steps via dip-switch. See dip-switch settings in page 3 for details.

Driver performance

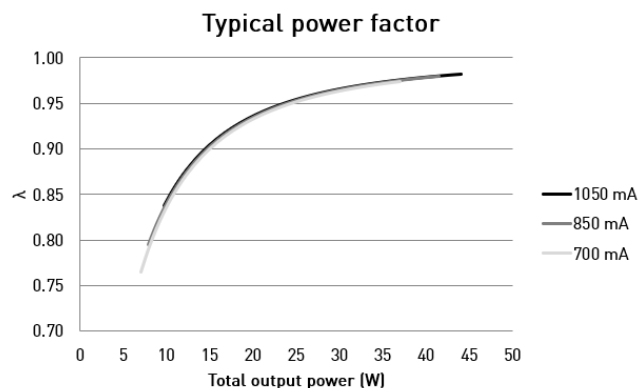
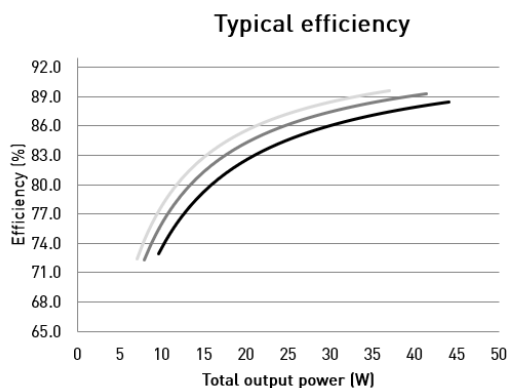

Operating Conditions and Characteristics

Absolute highest allowed t_c point temperature	85 °C
T_c life (50 000 h) temperature	85 °C
Ambient temperature range	-20 °C .. +45 °C*
Storage temperature range	-40 °C ... +80 °C
Maximum relative humidity	No condensation
Life time (90 % survival rate)	50 000 h, at $t_c = 85$ °C

*) For other than independent use, higher t_g of the controlgear possible as long as highest allowed t_c point temperature is not exceeded

Amplitude dimming technology

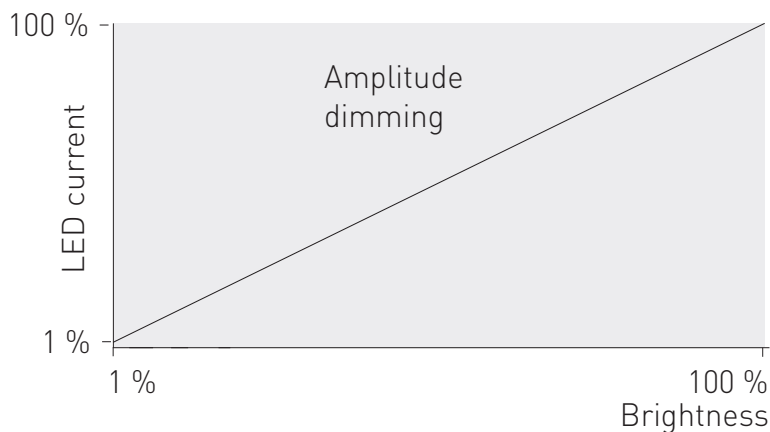

Dimming range	Dimming technology
1 % – 100 %	Amplitude (DC)

LC44MINI-DA-700-1050 LED driver implements amplitude dimming technology across whole dimming range. Amplitude dimming offers the best available technology for dimming the light output in an accurate and flicker-free way to ensure high quality lighting in even the most demanding situations such as camera recording applications. Amplitude dimming technology complies with IEEE 1789-2015 recommendations of current modulation to mitigate health risks to viewers.

Quantity of drivers per miniature circuit breaker 16 A Type C

Based on inrush current I_{peak}	Typ. peak inrush current I_{peak}	1/2 value time, Δt
75 pcs	30 A	100 μs

CONVERSION TABLE FOR OTHER TYPES OF MINIATURE CIRCUIT BREAKER

MCB type	Relative quantity of LED drivers
B 10 A	37 %
B 16 A	60 %
B 20 A	75 %
C 10 A	62 %
C 16 A	100 % (see table above)
C 20 A	125 %

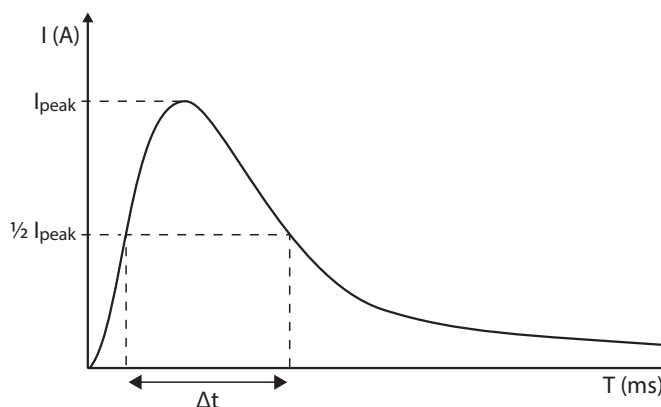

CONTINUOUS CURRENT

Total continuous current of the drivers and installation environment must always be considered and taken into calculations when installing drivers behind miniature circuit breaker. Example calculation of total drivers amount limited by continuous current: $n(I_{cont}) = (16 A (I_{nom,Ta}) / \text{“nominal mains current with full load”}) \times 0.76$. This calculation is an example according to recommended precautions due to multiple adjacent circuit breakers (> 9 MCBs) and installation environment (T_a 30 degrees); variables may vary according to the use case. Both inrush current and continuous current calculations are based on ABB S200 series circuit breakers. More specific information in ABB series S200 circuit breaker documentation.

NOTE! Type C MCB's are strongly recommended to use with LED lighting. Please see more details in "MCB information" document in each driver product page in "downloads & links" section.

Connections and Mechanical Data

Wire size	0.5 mm ² – 1.5 mm ²
Wire type	Solid core and fine-stranded
Wire insulation	According to EN 60598
Maximum driver to LED wire length	1.5 m
Weight	175 g
IP rating	IP20

Connections

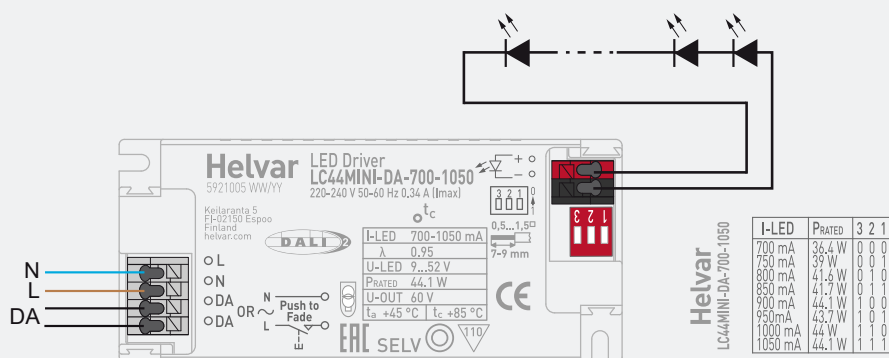

Note:

- Not suitable for load side switching operation
- Push to Fade functionality available since revision B

Dimensions (mm)

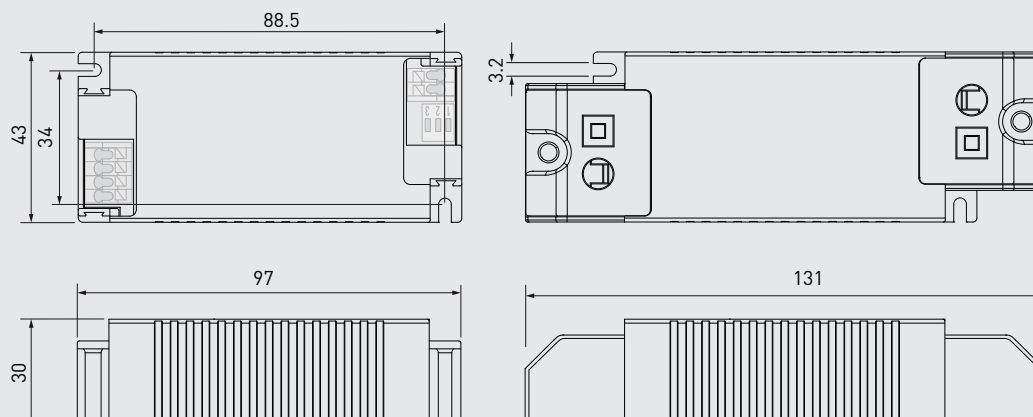

In LC44MINI-DA-700-1050, the current can be set with dip-switches. With each combination of switch setup, a different output current value can be set. The maximum value can be reached with all switches set to "1" (pushed downwards, away from the connectors, see connections picture above) and minimum with all switches set to "0" (pushed upwards, towards the connectors). The output current values according to the dip-switch settings are presented below.

Dip-switch combinations and currents (Nominal I_{out} (±5 % tol.))

Dip-Switch combination	111	110	101	100	011	010	001	000
I _{out} (mA)	1050	1000	950	900	850	800	750	700
Voltage range	9 - 42 V	9 - 44 V	9 - 46 V	9 - 49 V	9 - 49 V	9 - 52 V	9 - 52 V	9 - 52 V

LC44MINI-DA-700-1050 LED driver is suited for built-in usage in luminaires. With external strain relief (LC-SR-MINI), independent use is possible too. In order to have safe and reliable LED driver operation, the LED luminaires will need to comply with the relevant standards and regulations (e.g. IEC/EN 60598-1). The LED luminaire shall be designed to adequately protect the LED driver from dust, moisture and pollution. The luminaire manufacturer is responsible for the correct choice and installation of the LED drivers according to the application and product datasheets. Operating conditions of the LED drivers may never exceed the specifications as per the product datasheet.

Installation & operation

Maximum ambient and t_c temperature:

- For built-in components inside luminaires, the t_a ambient temperature range is a guideline given for the optimum operating environment. However, integrator must always ensure proper thermal management (i.e. mounting base of the driver, air flow etc.) so that the t_c point temperature does not exceed the t_c maximum limit in any circumstance.
- Reliable operation and lifetime is only guaranteed if the maximum t_c point temperature is not exceeded under the conditions of use.

Current setting via dip-switch

LC44MINI-DA-700-1050 LED driver features a constant current output adjustable via dip-switch combinations.

- For the combination/current values, refer to the table on page 4.

Miniature Circuit Breakers (MCB)

- Type-C MCB's with trip characteristics in according to EN 60898 are recommended.
- Please see more details in "MCB information" document in each driver product page in "downloads & links" section.

Lamp failure functionality

No load

When open load is detected, driver limits output voltage according to $U_{out} (max)$ (abnormal).

Overload

The driver can withstand output overload. When overload occurs, the driver goes to standby and returns through mains reset.

Short circuit

The driver can withstand output short circuit. When short circuit occurs, the driver goes to standby and returns through mains reset.

Push to Fade

Push to Fade solution includes additional fading behavior, which provides smooth transition between on and off states. Please note that Push to Fade is not compatible to be installed in the same circuit with Helvar Switch-Control or Switch-Control 2 devices.

Use of Push to Fade functionality

- Maximum numbers of LED drivers to be connected to one switch is 30.
- Ensure that all components connected to Push to Fade circuitry are mains rated.

- The transition between 0 to 100% (when turned ON / OFF) is ~ 1 second.

Before installation, please refer to the user guide at www.helvar.com.

Conformity & standards

General and safety requirements	EN 61347-1: 2015
Particular safety requirements for DC or AC supplied electronic control gear for LED modules	EN 61347-2-13: 2014 + A1: 2017
Thermal protection class	EN 61347, C5e
Mains current harmonics	EN 61000-3-2: 2014
Limits for voltage fluctuations and flicker	EN 61000-3-3: 2013
Radio frequency interference	EN 55015: 2013
Immunity standard	EN 61547: 2009
Performance requirements	EN 62384: 2006+ A1:2009
Digital addressing lighting interface:	
General requirements for DALI system	EN 62386-101 (DALI-2)
Requirements for DALI control gear	EN 62386-102 (DALI-2)
Requirements for control gear of LED modules (DALI Device Type 6)	EN 62386-207 (DALI-2)
Recommended Practices for Modulating Current in High-Brightness LEDs for Mitigating Health Risks to Viewers	IEEE 1789-2015
Compliant with relevant EU directives	
RoHS/REACH compliant	
ENEC and CE marked	

Label symbols



Safety isolating control gear with short circuit protection (SELV control gear).



Double insulated control gear suitable for built-in use.



Thermally controlled control gear, incorporating means of protection against overheating to prevent the case temperature under any conditions of use from exceeding 110 °C.



DALI-2 certified control gear.